



IEC 62305-2

Edition 2.0 2010-12

# INTERNATIONAL STANDARD



---

**Protection against lightning –  
Part 2: Risk management**

INTERNATIONAL  
ELECTROTECHNICAL  
COMMISSION

PRICE CODE **XC**

---

ICS 29.020; 91.120.40

ISBN 978-2-88912-281-3

## CONTENTS

FOREWORD.....	6
INTRODUCTION .....	8
1 Scope.....	10
2 Normative references.....	10
3 Terms, definitions, symbols and abbreviations.....	10
3.1 Terms and definitions .....	10
3.2 Symbols and abbreviations .....	16
4 Explanation of terms .....	19
4.1 Damage and loss .....	19
4.1.1 Source of damage.....	19
4.1.2 Types of damage .....	19
4.1.3 Types of loss .....	19
4.2 Risk and risk components .....	20
4.2.1 Risk.....	20
4.2.2 Risk components for a structure due to flashes to the structure.....	21
4.2.3 Risk component for a structure due to flashes near the structure.....	21
4.2.4 Risk components for a structure due to flashes to a line connected to the structure .....	21
4.2.5 Risk component for a structure due to flashes near a line connected to the structure .....	21
4.3 Composition of risk components .....	22
5 Risk management.....	23
5.1 Basic procedure.....	23
5.2 Structure to be considered for risk assessment .....	23
5.3 Tolerable risk $R_T$ .....	24
5.4 Specific procedure to evaluate the need of protection .....	24
5.5 Procedure to evaluate the cost effectiveness of protection .....	25
5.6 Protection measures.....	28
5.7 Selection of protection measures .....	28
6 Assessment of risk components .....	28
6.1 Basic equation.....	28
6.2 Assessment of risk components due to flashes to the structure (S1).....	29
6.3 Assessment of the risk component due to flashes near the structure (S2) .....	29
6.4 Assessment of risk components due to flashes to a line connected to the structure (S3) .....	29
6.5 Assessment of risk component due to flashes near a line connected to the structure (S4) .....	30
6.6 Summary of risk components .....	31
6.7 Partitioning of a structure in zones $Z_S$ .....	31
6.8 Partitioning of a line into sections $S_L$ .....	32
6.9 Assessment of risk components in a structure with zones $Z_S$ .....	32
6.9.1 General criteria.....	32
6.9.2 Single zone structure.....	32
6.9.3 Multi-zone structure.....	32
6.10 Cost-benefit analysis for economic loss (L4) .....	33
Annex A (informative) Assessment of annual number $N$ of dangerous events.....	34
Annex B (informative) Assessment of probability $P_X$ of damage.....	42

Annex C (informative) Assessment of amount of loss $L_X$ .....	50
Annex D (informative) Evaluation of costs of loss.....	57
Annex E (informative) Case study .....	58
Bibliography.....	84
Figure 1 – Procedure for deciding the need of protection and for selecting protection measures .....	26
Figure 2 – Procedure for evaluating the cost-effectiveness of protection measures .....	27
Figure A.1 – Collection area $A_D$ of an isolated structure .....	35
Figure A.2 – Complex shaped structure .....	36
Figure A.3 – Different methods to determine the collection area for the given structure.....	37
Figure A.4 – Structure to be considered for evaluation of collection area $A_D$ .....	38
Figure A.5 – Collection areas ( $A_D$ , $A_M$ , $A_I$ , $A_L$ ) .....	41
Figure E.1 – Country house .....	58
Figure E.2 – Office building .....	63
Figure E.3 – Hospital .....	69
Figure E.4 – Apartment block.....	80
Table 1 – Sources of damage, types of damage and types of loss according to the point of strike.....	20
Table 2 – Risk components to be considered for each type of loss in a structure.....	22
Table 3 – Factors influencing the risk components.....	23
Table 4 – Typical values of tolerable risk $R_T$ .....	24
Table 5 – Parameters relevant to the assessment of risk components.....	30
Table 6 – Risk components for different types of damage and source of damage .....	31
Table A.1 – Structure location factor $C_D$ .....	39
Table A.2 – Line installation factor $C_I$ .....	40
Table A.3 – Line type factor $C_T$ .....	40
Table A.4 – Line environmental factor $C_E$ .....	40
Table B.1 – Values of probability $P_{TA}$ that a flash to a structure will cause shock to living beings due to dangerous touch and step voltages .....	42
Table B.2 – Values of probability $P_B$ depending on the protection measures to reduce physical damage .....	43
Table B.3 – Value of the probability $P_{SPD}$ as a function of LPL for which SPDs are designed .....	44
Table B.4 – Values of factors $C_{LD}$ and $C_{LI}$ depending on shielding, grounding and isolation conditions.....	44
Table B.5 – Value of factor $K_{S3}$ depending on internal wiring.....	46
Table B.6 – Values of probability $P_{TU}$ that a flash to an entering line will cause shock to living beings due to dangerous touch voltages .....	47
Table B.7 – Value of the probability $P_{EB}$ as a function of LPL for which SPDs are designed .....	47
Table B.8 – Values of the probability $P_{LD}$ depending on the resistance $R_S$ of the cable screen and the impulse withstand voltage $U_W$ of the equipment .....	47
Table B.9 – Values of the probability $P_{LI}$ depending on the line type and the impulse withstand voltage $U_W$ of the equipment.....	49

Table C.1 – Type of loss L1: Loss values for each zone .....	51
Table C.2 – Type of loss L1: Typical mean values of $L_T$ , $L_F$ and $L_O$ .....	51
Table C.3 – Reduction factor $r_t$ as a function of the type of surface of soil or floor.....	52
Table C.4 – Reduction factor $r_p$ as a function of provisions taken to reduce the consequences of fire.....	52
Table C.5 – Reduction factor $r_f$ as a function of risk of fire or explosion of structure .....	53
Table C.6 – Factor $h_z$ increasing the relative amount of loss in presence of a special hazard.....	53
Table C.7 – Type of loss L2: Loss values for each zone .....	54
Table C.8 – Type of loss L2: Typical mean values of $L_F$ and $L_O$ .....	54
Table C.9 – Type of loss L3: Loss values for each zone .....	54
Table C.10 – Type of loss L3: Typical mean value of $L_F$ .....	55
Table C.11 – Type of loss L4: Loss values for each zone.....	55
Table C.12 – Type of loss L4: Typical mean values of $L_T$ , $L_F$ and $L_O$ .....	56
Table E.1 – Country house: Environment and structure characteristics.....	59
Table E.2 – Country house: Power line .....	59
Table E.3 – Country house: Telecom line (TLC).....	59
Table E.4 – Country house: Factors valid for zone $Z_2$ (inside the building).....	60
Table E.5 – Country house: Collection areas of structure and lines.....	61
Table E.6 – Country house: Expected annual number of dangerous events .....	61
Table E.7 – Country house: Risk $R_1$ for the unprotected structure (values $\times 10^{-5}$ ).....	62
Table E.8 – Country house: Risk components relevant to risk $R_1$ for protected structure .....	62
Table E.9 – Office building: Environment and structure characteristics.....	63
Table E.10 – Office building: Power line.....	64
Table E.11 – Office building: Telecom line .....	64
Table E.12 – Office building: Distribution of persons into zones.....	65
Table E.13 – Office building: Factors valid for zone $Z_1$ (entrance area outside).....	65
Table E.14 – Office building: Factors valid for zone $Z_2$ (garden outside).....	66
Table E.15 – Office building: Factors valid for zone $Z_3$ (archive).....	66
Table E.16 – Office building: Factors valid for zone $Z_4$ (offices).....	66
Table E.17 – Office building: Factors valid for zone $Z_5$ (computer centre).....	67
Table E.18 – Office building: Collection areas of structure and lines .....	67
Table E.19 – Office building: Expected annual number of dangerous events.....	68
Table E.20 – Office building: Risk $R_1$ for the unprotected structure (values $\times 10^{-5}$ ).....	68
Table E.21 – Office building: Risk $R_1$ for the protected structure (values $\times 10^{-5}$ ).....	69
Table E.22 – Hospital: Environment and global structure characteristics .....	70
Table E.23 – Hospital: Power line.....	70
Table E.24 – Hospital: Telecom line .....	70
Table E.25 – Hospital: Distribution of persons and of economic values into zones.....	71
Table E.26 – Hospital: Factors valid for zone $Z_1$ (outside the building).....	72
Table E.27 – Hospital: Factors valid for zone $Z_2$ (rooms block).....	72
Table E.28 – Hospital: Factors valid for zone $Z_3$ (operating block) .....	73
Table E.29 – Hospital: Factors valid for zone $Z_4$ (intensive care unit).....	74
Table E.30 – Hospital: Collection areas of structure and lines .....	74

Table E.31 – Hospital: Expected annual number of dangerous events.....	75
Table E.32 – Hospital: Risk $R_1$ – Values of probability $P$ for the unprotected structure.....	75
Table E.33 – Hospital: Risk $R_1$ for the unprotected structure (values $\times 10^{-5}$ ) .....	75
Table E.34 – Hospital: Risk $R_1$ for the protected structure according to solution a) (values $\times 10^{-5}$ ) .....	77
Table E.35 – Hospital: Risk $R_1$ for the protected structure according to solution b) (values $\times 10^{-5}$ ) .....	77
Table E.36 – Hospital: Risk $R_1$ for the protected structure according to solution c) (values $\times 10^{-5}$ ) .....	78
Table E.37 – Hospital: Cost of loss $C_L$ (unprotected) and $C_{RL}$ (protected) .....	78
Table E.38 – Hospital: Rates relevant to the protection measures.....	79
Table E.39 – Hospital: Cost $C_P$ and $C_{PM}$ of protection measures (values in \$) .....	79
Table E.40 – Hospital: Annual saving of money (values in \$).....	79
Table E.41 – Apartment block: Environment and global structure characteristics.....	80
Table E.42 – Apartment block: Power line .....	80
Table E.43 – Apartment block: Telecom line.....	81
Table E.44 – Apartment block: Factors valid for zone $Z_2$ (inside the building) .....	82
Table E.45 – Apartment block: Risk $R_1$ for the apartment block depending on protection measures .....	83

# INTERNATIONAL ELECTROTECHNICAL COMMISSION

---

## PROTECTION AGAINST LIGHTNING –

### Part 2: Risk management

#### FOREWORD

- 1) The International Electrotechnical Commission (IEC) is a worldwide organization for standardization comprising all national electrotechnical committees (IEC National Committees). The object of IEC is to promote international co-operation on all questions concerning standardization in the electrical and electronic fields. To this end and in addition to other activities, IEC publishes International Standards, Technical Specifications, Technical Reports, Publicly Available Specifications (PAS) and Guides (hereafter referred to as "IEC Publication(s)"). Their preparation is entrusted to technical committees; any IEC National Committee interested in the subject dealt with may participate in this preparatory work. International, governmental and non-governmental organizations liaising with the IEC also participate in this preparation. IEC collaborates closely with the International Organization for Standardization (ISO) in accordance with conditions determined by agreement between the two organizations.
- 2) The formal decisions or agreements of IEC on technical matters express, as nearly as possible, an international consensus of opinion on the relevant subjects since each technical committee has representation from all interested IEC National Committees.
- 3) IEC Publications have the form of recommendations for international use and are accepted by IEC National Committees in that sense. While all reasonable efforts are made to ensure that the technical content of IEC Publications is accurate, IEC cannot be held responsible for the way in which they are used or for any misinterpretation by any end user.
- 4) In order to promote international uniformity, IEC National Committees undertake to apply IEC Publications transparently to the maximum extent possible in their national and regional publications. Any divergence between any IEC Publication and the corresponding national or regional publication shall be clearly indicated in the latter.
- 5) IEC itself does not provide any attestation of conformity. Independent certification bodies provide conformity assessment services and, in some areas, access to IEC marks of conformity. IEC is not responsible for any services carried out by independent certification bodies.
- 6) All users should ensure that they have the latest edition of this publication.
- 7) No liability shall attach to IEC or its directors, employees, servants or agents including individual experts and members of its technical committees and IEC National Committees for any personal injury, property damage or other damage of any nature whatsoever, whether direct or indirect, or for costs (including legal fees) and expenses arising out of the publication, use of, or reliance upon, this IEC Publication or any other IEC Publications.
- 8) Attention is drawn to the Normative references cited in this publication. Use of the referenced publications is indispensable for the correct application of this publication.
- 9) Attention is drawn to the possibility that some of the elements of this IEC Publication may be the subject of patent rights. IEC shall not be held responsible for identifying any or all such patent rights.

International Standard IEC 62305-2 has been prepared by IEC technical committee 81: Lightning protection.

This second edition cancels and replaces the first edition, published in 2006, and constitutes a technical revision.

This edition includes the following significant technical changes with respect to the previous edition:

- 1) Risk assessment for services connected to structures is excluded from the scope.
- 2) Injuries of living beings caused by electric shock inside the structure are considered.
- 3) Tolerable risk of loss of cultural heritage is lowered from  $10^{-3}$  to  $10^{-4}$ . The value of tolerable risk of loss of economic value ( $R_T = 10^{-3}$ ) is introduced, to be used when data for cost/benefit analysis are not available.
- 4) Extended damage to surroundings structures or to the environment is considered.
- 5) Improved equations are provided for evaluation of

- collection areas relevant to flashes nearby a structure,
- collection areas relevant to flashes to and nearby a line,
- probabilities that a flash can cause damage,
- loss factors even in structures with risk of explosion,
- risk relevant to a zone of a structure,
- cost of loss.

6) Tables are provided to select the relative amount of loss in all cases.

7) Impulse withstand voltage level of equipments was extended down to 1 kV.

The text of this standard is based on the following documents:

FDIS	Report on voting
81/371/FDIS	81/381/RVD

Full information on the voting for the approval of this standard can be found in the report on voting indicated in the above table.

This publication has been drafted in accordance with the ISO/IEC Directives, Part 2.

A list of all the parts in the IEC 62305 series, under the general title *Protection against lightning*, can be found on the IEC website.

The committee has decided that the contents of this publication will remain unchanged until the stability date indicated on the IEC web site under "<http://webstore.iec.ch>" in the data related to the specific publication. At this date, the publication will be

- reconfirmed,
- withdrawn,
- replaced by a revised edition, or
- amended.

A bilingual version of this standard may be issued at a later date.

**IMPORTANT – The 'colour inside' logo on the cover page of this publication indicates that it contains colours which are considered to be useful for the correct understanding of its contents. Users should therefore print this document using a colour printer.**

## INTRODUCTION

Lightning flashes to earth may be hazardous to structures and to lines.

The hazard to a structure can result in

- damage to the structure and to its contents,
- failure of associated electrical and electronic systems,
- injury to living beings in or close to the structure.

Consequential effects of the damage and failures may be extended to the surroundings of the structure or may involve its environment.

To reduce the loss due to lightning, protection measures may be required. Whether they are needed, and to what extent, should be determined by risk assessment.

The risk, defined in this part of IEC 62305 as the probable average annual loss in a structure due to lightning flashes, depends on:

- the annual number of lightning flashes influencing the structure;
- the probability of damage by one of the influencing lightning flashes;
- the mean amount of consequential loss.

Lightning flashes influencing the structure may be divided into

- flashes terminating on the structure,
- flashes terminating near the structure, direct to connected lines (power, telecommunication lines,) or near the lines.

Flashes to the structure or a connected line may cause physical damage and life hazards. Flashes near the structure or line as well as flashes to the structure or line may cause failure of electrical and electronic systems due to overvoltages resulting from resistive and inductive coupling of these systems with the lightning current.

Moreover, failures caused by lightning overvoltages in users' installations and in power supply lines may also generate switching type overvoltages in the installations.

NOTE Malfunctioning of electrical and electronic systems is not covered by the IEC 62305 series. Reference should be made to IEC 61000-4-5 <sup>[1]</sup>.

The number of lightning flashes influencing the structure depends on the dimensions and the characteristics of the structure and of the connected lines, on the environmental characteristics of the structure and the lines, as well as on lightning ground flash density in the region where the structure and the lines are located.

The probability of lightning damage depends on the structure, the connected lines, and the lightning current characteristics, as well as on the type and efficiency of applied protection measures.

The annual mean amount of the consequential loss depends on the extent of damage and the consequential effects which may occur as result of a lightning flash.

The effect of protection measures results from the features of each protection measure and may reduce the damage probabilities or the amount of consequential loss.

---

<sup>1</sup> Figures in square brackets refer to the bibliography.



The decision to provide lightning protection may be taken regardless of the outcome of risk assessment where there is a desire that there be no avoidable risk.

## PROTECTION AGAINST LIGHTNING –

### Part 2: Risk management

#### 1 Scope

This part of IEC 62305 is applicable to risk assessment for a structure due to lightning flashes to earth.

Its purpose is to provide a procedure for the evaluation of such a risk. Once an upper tolerable limit for the risk has been selected, this procedure allows the selection of appropriate protection measures to be adopted to reduce the risk to or below the tolerable limit.

#### 2 Normative references

The following referenced documents are indispensable for the application of this document. For dated references, only the edition cited applies. For undated references, the latest edition of the referenced document (including any amendments) applies.

IEC 62305-1:2010, *Protection against lightning – Part 1: General principles*

IEC 62305-3:2010, *Protection against lightning – Part 3: Physical damage to structures and life hazard*

IEC 62305-4:2010, *Protection against lightning – Part 4: Electrical and electronic systems within structures*

#### 3 Terms, definitions, symbols and abbreviations

For the purposes of this document, the following terms, definitions, symbols and abbreviations, some of which have already been cited in Part 1 but are repeated here for ease of reading, as well as those given in other parts of IEC 62305, apply.

##### 3.1 Terms and definitions

###### 3.1.1

###### **structure to be protected**

structure for which protection is required against the effects of lightning in accordance with this standard

NOTE A structure to be protected may be part of a larger structure.

###### 3.1.2

###### **structures with risk of explosion**

structures containing solid explosives materials or hazardous zones as determined in accordance with IEC 60079-10-1<sup>[2]</sup> and IEC 60079-10-2<sup>[3]</sup>

###### 3.1.3

###### **structures dangerous to the environment**

structures which may cause biological, chemical or radioactive emission as a consequence of lightning (such as chemical, petrochemical, nuclear plants, etc.)

**3.1.4****urban environment**

area with a high density of buildings or densely populated communities with tall buildings

NOTE 'Town centre' is an example of an urban environment.

**3.1.5****suburban environment**

area with a medium density of buildings

NOTE 'Town outskirts' is an example of a suburban environment.

**3.1.6****rural environment**

area with a low density of buildings

NOTE 'Countryside' is an example of a rural environment.

**3.1.7****rated impulse withstand voltage level**

$U_w$

impulse withstand voltage assigned by the manufacturer to the equipment or to a part of it, characterizing the specified withstand capability of its insulation against (transient) overvoltages

[IEC 60664-1:2007, definition 3.9.2, modified]<sup>[4]</sup>

NOTE For the purposes of this part of IEC 62305, only the withstand voltage between live conductors and earth is considered.

**3.1.8****electrical system**

system incorporating low voltage power supply components

**3.1.9****electronic system**

system incorporating sensitive electronic components such as telecommunication equipment, computer, control and instrumentation systems, radio systems, power electronic installations

**3.1.10****internal systems**

electrical and electronic systems within a structure

**3.1.11****line**

power line or telecommunication line connected to the structure to be protected

**3.1.12****telecommunication lines**

lines intended for communication between equipment that may be located in separate structures, such as phone lines and data lines

**3.1.13****power lines**

distribution lines feeding electrical energy into a structure to power electrical and electronic equipment located there, such as low voltage (LV) or high voltage (HV) electric mains

**3.1.14****dangerous event**

lightning flash to or near the structure to be protected, or to or near a line connected to the structure to be protected that may cause damage

**3.1.15**

**lightning flash to a structure**

lightning flash striking a structure to be protected

**3.1.16**

**lightning flash near a structure**

lightning flash striking close enough to a structure to be protected that it may cause dangerous overvoltages

**3.1.17**

**lightning flash to a line**

lightning flash striking a line connected to the structure to be protected

**3.1.18**

**lightning flash near a line**

lightning flash striking close enough to a line connected to the structure to be protected that it may cause dangerous overvoltages

**3.1.19**

**number of dangerous events due to flashes to a structure**

$N_D$

expected average annual number of dangerous events due to lightning flashes to a structure

**3.1.20**

**number of dangerous events due to flashes to a line**

$N_L$

expected average annual number of dangerous events due to lightning flashes to a line

**3.1.21**

**number of dangerous events due to flashes near a structure**

$N_M$

expected average annual number of dangerous events due to lightning flashes near a structure

**3.1.22**

**number of dangerous events due to flashes near a line**

$N_I$

expected average annual number of dangerous events due to lightning flashes near a line

**3.1.23**

**lightning electromagnetic impulse**

LEMP

all electromagnetic effects of lightning current via resistive, inductive and capacitive coupling, which create surges and electromagnetic fields

**3.1.24**

**surge**

transient created by LEMP that appears as an overvoltage and/or overcurrent

**3.1.25**

**node**

point on a line from which onward surge propagation can be assumed to be neglected

NOTE Examples of nodes are a point on a power line branch distribution at an HV/LV transformer or on a power substation, a telecommunication exchange or an equipment (e.g. multiplexer or xDSL equipment) on a telecommunication line.

**3.1.26****physical damage**

damage to a structure (or to its contents) due to mechanical, thermal, chemical or explosive effects of lightning

**3.1.27****injury to living beings**

permanent injuries, including loss of life, to people or to animals by electric shock due to touch and step voltages caused by lightning

NOTE Although living beings may be injured in other ways, in this part of IEC 62305 the term 'injury to living beings' is limited to the threat due to electrical shock (type of damage D1).

**3.1.28****failure of electrical and electronic systems**

permanent damage of electrical and electronic systems due to LEMP

**3.1.29****probability of damage**

$P_x$

probability that a dangerous event will cause damage to or in the structure to be protected

**3.1.30****loss**

$L_x$

mean amount of loss (humans and goods) consequent on a specified type of damage due to a dangerous event, relative to the value (humans and goods) of the structure to be protected

**3.1.31****risk**

$R$

value of probable average annual loss (humans and goods) due to lightning, relative to the total value (humans and goods) of the structure to be protected

**3.1.32****risk component**

$R_x$

partial risk depending on the source and the type of damage

**3.1.33****tolerable risk**

$R_T$

maximum value of the risk which can be tolerated for the structure to be protected

**3.1.34****zone of a structure**

$Z_s$

part of a structure with homogeneous characteristics where only one set of parameters is involved in assessment of a risk component

**3.1.35****section of a line**

$S_L$

part of a line with homogeneous characteristics where only one set of parameters is involved in the assessment of a risk component

**3.1.36****lightning protection zone**

LPZ

zone where the lightning electromagnetic environment is defined

NOTE The zone boundaries of an LPZ are not necessarily physical boundaries (e.g. walls, floor and ceiling).

**3.1.37**  
**lightning protection level**

LPL

number related to a set of lightning current parameters values relevant to the probability that the associated maximum and minimum design values will not be exceeded in naturally occurring lightning

NOTE Lightning protection level is used to design protection measures according to the relevant set of lightning current parameters.

**3.1.38**  
**protection measures**

measures to be adopted in the structure to be protected, in order to reduce the risk

**3.1.39**  
**lightning protection**

LP

complete system for protection of structures against lightning, including their internal systems and contents, as well as persons, in general consisting of an LPS and SPM

**3.1.40**  
**lightning protection system**

LPS

complete system used to reduce physical damage due to lightning flashes to a structure

NOTE It consists of both external and internal lightning protection systems.

**3.1.41**  
**LEMP protection measures**

SPM

measures taken to protect internal systems against the effects of LEMP

NOTE This is part of overall lightning protection

**3.1.42**  
**magnetic shield**

closed, metallic, grid-like or continuous screen enveloping the structure to be protected, or part of it, used to reduce failures of electrical and electronic systems

**3.1.43**  
**lightning protective cable**

special cable with increased dielectric strength and whose metallic sheath is in continuous contact with the soil either directly or by use of conducting plastic covering

**3.1.44**  
**lightning protective cable duct**

cable duct of low resistivity in contact with the soil

EXAMPLE Concrete with interconnected structural steel reinforcements or metallic duct.

**3.1.45**  
**surge protective device**

SPD

device intended to limit transient overvoltages and divert surge currents; contains at least one non-linear component

**3.1.46****coordinated SPD system**

SPDs properly selected, coordinated and installed to form a system intended to reduce failures of electrical and electronic systems

**3.1.47****isolating interfaces**

devices which are capable of reducing conducted surges on lines entering the LPZ

NOTE 1 These include isolation transformers with earthed screen between windings, metal-free fibre optic cables and opto-isolators.

NOTE 2 Insulation withstand characteristics of these devices are suitable for this application intrinsically or via SPD.

**3.1.48****lightning equipotential bonding****EB**

bonding to LPS of separated metallic parts, by direct conductive connections or via surge protective devices, to reduce potential differences caused by lightning current

**3.1.49****zone 0**

place in which an explosive atmosphere consisting of a mixture of air and flammable substances in the form of gas, vapour or mist is present continuously or for long periods or frequently

(IEC 60050-426:2008, 426-03-03, modified)<sup>[5]</sup>

**3.1.50****zone 1**

place in which an explosive atmosphere consisting of a mixture of air and flammable substances in the form of gas, vapour or mist is likely to occur in normal operation occasionally

(IEC 60050-426:2008, 426-03-04, modified)<sup>[5]</sup>

**3.1.51****zone 2**

place in which an explosive atmosphere consisting of a mixture of air and flammable substances in the form of gas, vapour or mist is not likely to occur in normal operation but, if it does occur, will persist for a short period only

NOTE 1 In this definition, the word "persist" means the total time for which the flammable atmosphere will exist. This will normally comprise the total of the duration of the release, plus the time taken for the flammable atmosphere to disperse after the release has stopped.

NOTE 2 Indications of the frequency of the occurrence and duration may be taken from codes relating to specific industries or applications.

(IEC 60050-426:2008, 426-03-05, modified)<sup>[5]</sup>

**3.1.52****zone 20**

place in which an explosive atmosphere, in the form of a cloud of combustible dust in air, is present continuously, or for long periods, or frequently

(IEC 60079-10-2:2009, 6.2, modified)<sup>[3]</sup>

**3.1.53**

**zone 21**

place in which an explosive atmosphere, in the form of a cloud of combustible dust in air, is likely to occur in normal operation occasionally

(IEC 60079-10-2:2009, 6.2, modified)<sup>[3]</sup>

**3.1.54**

**zone 22**

place in which an explosive atmosphere, in the form of a cloud of combustible dust in air, is not likely to occur in normal operation but, if it does occur, will persist for a short period only

(IEC 60079-10-2:2009, 6.2, modified)<sup>[3]</sup>

**3.2 Symbols and abbreviations**

<i>a</i>	Amortization rate .....	Annex D
$A_D$	Collection area for flashes to an isolated structure .....	A.2.1.1
$A_{DJ}$	Collection area for flashes to an adjacent structure .....	A.2.5
$A_{D'}$	Collection area attributed to an elevated roof protrusion .....	A.2.1.2
$A_I$	Collection area for flashes near a line .....	A.5
$A_L$	Collection area for flashes to a line.....	A.4
$A_M$	Collection area for flashes striking near the structure .....	A.3
<b>B</b>	<b>Building .....</b>	<b>A.2</b>
$C_D$	Location factor.....	Table A.1
$C_{DJ}$	Location factor of an adjacent structure.....	A.2.5
$C_E$	Environmental factor .....	Table A.4
$C_I$	Installation factor of the line.....	Table A.2
$C_L$	Annual cost of total loss in absence of protection measures .....	5.5; Annex D
$C_{LD}$	Factor depending on shielding, grounding and isolation conditions of the line for flashes to a line .....	Annex B
$C_{LI}$	Factor depending on shielding, grounding and isolation conditions of the line for flashes near a line .....	Annex B
$C_{LZ}$	Cost of loss in a zone.....	Annex D
$C_P$	Cost of protection measures .....	Annex D
$C_{PM}$	Annual cost of selected protection measures .....	5.5; Annex D
$C_{RL}$	Annual cost of residual loss .....	5.5; Annex D
$C_{RLZ}$	Cost of residual loss in a zone.....	Annex D
$C_T$	Line type factor for a HV/LV transformer on the line .....	Table A.3
$c_a$	Value of the animals in the zone, in currency .....	C.6
$c_b$	Value of the building relevant to the zone, in currency .....	C.6
$c_c$	Value of the content in the zone, in currency .....	C.6
$c_e$	Total value of goods in dangerous place outside the structure, in currency .....	C.6
$c_s$	Value of the internal systems (including their activities) in the zone, in currency.....	C.6
$c_t$	Total value of the structure, in currency.....	C.5; C.6
$c_z$	Value of the cultural heritage in the zone, in currency.....	C.5
<b>D1</b>	<b>Injury to living beings by electric shock .....</b>	<b>4.1.2</b>
<b>D2</b>	<b>Physical damage .....</b>	<b>4.1.2</b>
<b>D3</b>	<b>Failure of electrical and electronic systems.....</b>	<b>4.1.2</b>



$h_z$	Factor increasing the loss when a special hazard is present .....	Table C.6
$H$	Height of the structure .....	A.2.1.1
$H_J$	Height of the adjacent structure.....	A.2.5
$i$	Interest rate .....	Annex D
$K_{MS}$	Factor relevant to the performance of protection measures against LEMP .....	B.5
$K_{S1}$	Factor relevant to the screening effectiveness of the structure.....	B.5
$K_{S2}$	Factor relevant to the screening effectiveness of shields internal to the structure .....	B.5
$K_{S3}$	Factor relevant to the characteristics of internal wiring.....	B.5
$K_{S4}$	Factor relevant to the impulse withstand voltage of a system.....	B.5
$L$	Length of structure.....	A.2.1.1
$L_J$	Length of the adjacent structure .....	A.2.5
$L_A$	Loss due to injury to living beings by electric shock (flashes to structure).....	6.2
$L_B$	Loss in a structure related to physical damage (flashes to structure).....	6.2
$L_L$	Length of line section .....	A.4
$L_C$	Loss related to failure of internal systems (flashes to structure).....	6.2
$L_E$	Additional loss when the damage involves surrounding structures.....	C.3; C.6
$L_F$	Loss in a structure due to physical damage .....	Tables C.2, C8, C10, C12
$L_{FE}$	Loss due to physical damage outside the structure.....	C.3; C.6
$L_{FT}$	Total loss due to physical damage in and outside the structure.....	C.3; C.6
$L_M$	Loss related to failure of internal systems (flashes near structure) .....	6.3
$L_O$	Loss in a structure due to failure of internal systems .....	Tables C.2, C8, C12
$L_T$	Loss due to injury by electric shock .....	Tables C.2, C12
$L_U$	Loss due to injury of living beings by electric shock (flashes to line).....	6.4
$L_V$	Loss in a structure due to physical damage (flashes to line) .....	6.4
$L_W$	Loss related to failure of internal systems (flashes to line) .....	6.4
$L_X$	Loss consequent to damages relevant to structure .....	6.1
$L_Z$	Loss related to failure of internal systems (flashes near a line) .....	6.5
$L1$	Loss of human life.....	4.1.3
$L2$	Loss of service to the public.....	4.1.3
$L3$	Loss of cultural heritage .....	4.1.3
$L4$	Loss of economic value .....	4.1.3
$m$	Maintenance rate.....	Annex D
$N_X$	Number of dangerous events per annum .....	6.1
$N_D$	Number of dangerous events due to flashes to structure.....	A.2.4
$N_{DJ}$	Number of dangerous events due to flashes to adjacent structure.....	A.2.5
$N_G$	Lightning ground flash density.....	A.1
$N_I$	Number of dangerous events due to flashes near a line .....	A.5
$N_L$	Number of dangerous events due to flashes to a line.....	A.4
$N_M$	Number of dangerous events due to flashes near a structure.....	A.3
$n_z$	Number of possible endangered persons (victims or users not served).....	C.3; C.4
$n_t$	Expected total number of persons (or users served) .....	C.3; C.4
$P$	Probability of damage.....	Annex B
$P_A$	Probability of injury to living beings by electric shock (flashes to a structure) .....	6.2; B.2
$P_B$	Probability of physical damage to a structure (flashes to a structure) .....	Table B.2
$P_C$	Probability of failure of internal systems (flashes to a structure).....	6.2; B.4
$P_{EB}$	Probability reducing $P_U$ and $P_V$ depending on line characteristics and	

	withstand voltage of equipment when EB is installed .....	Table B.7
$P_{LD}$	Probability reducing $P_U$ , $P_V$ and $P_W$ depending on line characteristics and withstand voltage of equipment (flashes to connected line).....	Table B.8
$P_{LI}$	Probability reducing $P_Z$ depending on line characteristics and withstand voltage of equipment (flashes near a connected line) .....	Table B.9
$P_M$	Probability of failure of internal systems (flashes near a structure).....	6.3; B 5
$P_{MS}$	Probability reducing $P_M$ depending on shielding, wiring and withstand voltage of equipment .....	B.5
$P_{SPD}$	Probability reducing $P_C$ , $P_M$ , $P_W$ and $P_Z$ when a coordinated SPD system is installed .....	Table B.3
$P_{TA}$	Probability reducing $P_A$ depending on protection measures against touch and step voltages.....	Table B.1
$P_U$	Probability of injury to living beings by electric shock (flashes to a connected line).....	6.4; B.6
$P_V$	Probability of physical damage to a structure (flashes to a connected line).....	6.4; B.7
$P_W$	Probability of failure of internal systems (flashes to connected line).....	6.4; B.8
$P_X$	Probability of damage relevant to a structure .....	6.1
$P_Z$	Probability of failure of internal systems (flashes near a connected line).....	6.5; B.9
$r_t$	Reduction factor associated with the type of surface .....	C.3
$r_f$	Factor reducing loss depending on risk of fire .....	C.3
$r_p$	Factor reducing the loss due to provisions against fire.....	C.3
$R$	Risk .....	4.2
$R_A$	Risk component (injury to living beings – flashes to structure) .....	4.2.2
$R_B$	Risk component (physical damage to a structure – flashes to a structure).....	4.2.2
$R_C$	Risk component (failure of internal systems –flashes to structure) .....	4.2.2
$R_M$	Risk component (failure of internal systems – flashes near structure).....	4.2.3
$R_S$	Shield resistance per unit length of a cable.....	Table B.8
$R_T$	Tolerable risk .....	5.3; Table 4
$R_U$	Risk component (injury to living being – flashes to connected line) .....	4.2.4
$R_V$	Risk component (physical damage to structure – flashes to connected line).....	4.2.4
$R_W$	Risk component (failure of internal systems – flashes to connected line).....	4.2.4
$R_X$	Risk component for a structure.....	6.1
$R_Z$	Risk component (failure of internal systems – flashes near a line).....	4.2.5
$R_1$	Risk of loss of human life in a structure.....	4.2.1
$R_2$	Risk of loss of service to the public in a structure .....	4.2.1
$R_3$	Risk of loss of cultural heritage in a structure.....	4.2.1
$R_4$	Risk of loss of economic value in a structure .....	4.2.1
$R'_4$	Risk $R_4$ when protection measures are adopted .....	Annex D
$S$	Structure.....	A.2.2
$S_M$	Annual saving of money .....	Annex D
$S_L$	Section of a line.....	6.8
$S1$	Source of damage – Flashes to a structure.....	4.1.1
$S2$	Source of damage – Flashes near a structure .....	4.1.1
$S3$	Source of damage – Flashes to a line .....	4.1.1
$S4$	Source of damage – Flashes near a line.....	4.1.1
$t_e$	Time in hours per year of presence of people in a dangerous place outside the structure.....	C.3
$t_z$	Time in hours per year that persons are present in a dangerous place .....	C.2

$T_D$	Thunderstorm days per year .....	A.1
$U_W$	Rated impulse withstand voltage of a system.....	B.5
$w_m$	Mesh width.....	B.5
$W$	Width of structure .....	A.2.1.1
$W_J$	Width of the adjacent structure.....	A.2.5
$X$	Subscript identifying the relevant risk component.....	6.1
$Z_S$	Zones of a structure .....	6.7

## 4 Explanation of terms

### 4.1 Damage and loss

#### 4.1.1 Source of damage

The lightning current is the primary source of damage. The following sources are distinguished by the point of strike (see Table 1):

- S1: flashes to a structure,
- S2: flashes near a structure,
- S3: flashes to a line,
- S4: flashes near a line.

#### 4.1.2 Types of damage

A lightning flash may cause damage depending on the characteristics of the structure to be protected. Some of the most important characteristics are: type of construction, contents and application, type of service and protection measures provided.

For practical applications of this risk assessment, it is useful to distinguish between three basic types of damage which can appear as the consequence of lightning flashes. They are as follows (see Table 1):

- D1: injury to living beings by electric shock,
- D2: physical damage,
- D3: failure of electrical and electronic systems.

The damage to a structure due to lightning may be limited to a part of the structure or may extend to the entire structure. It may also involve surrounding structures or the environment (e.g. chemical or radioactive emissions).

#### 4.1.3 Types of loss

Each type of damage, alone or in combination with others, may produce a different consequential loss in the structure to be protected. The type of loss that may appear, depends on the characteristics of the structure itself and its content. The following types of loss shall be taken into account (see Table 1):

- L1: loss of human life (including permanent injury);
- L2: loss of service to the public;
- L3: loss of cultural heritage;
- L4: loss of economic value (structure, content, and loss of activity).

**Table 1 – Sources of damage, types of damage and types of loss according to the point of strike**

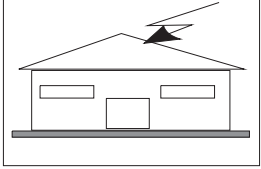
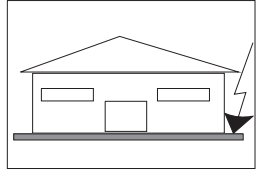
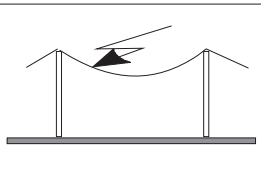
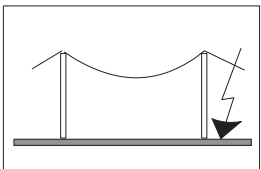
Lightning flash		Structure	
Point of strike	Source of damage	Type of damage	Type of loss
	S1	D1 D2 D3	L1, L4 <sup>a</sup> L1, L2, L3, L4 L1 <sup>b</sup> , L2, L4
	S2	D3	L1 <sup>b</sup> , L2, L4
	S3	D1 D2 D3	L1, L4 <sup>a</sup> L1, L2, L3, L4 L1 <sup>b</sup> , L2, L4
	S4	D3	L1 <sup>b</sup> , L2, L4
<p><sup>a</sup> Only for properties where animals may be lost.</p> <p><sup>b</sup> Only for structures with risk of explosion and for hospitals or other structures where failures of internal systems immediately endangers human life.</p>			

## 4.2 Risk and risk components

### 4.2.1 Risk

The risk,  $R$ , is the relative value of a probable average annual loss. For each type of loss which may appear in a structure, the relevant risk shall be evaluated.

The risks to be evaluated in a structure may be as follows:

- $R_1$ : risk of loss of a human life (including permanent injury),
- $R_2$ : risk of loss of service to the public,
- $R_3$ : risk of loss of cultural heritage,
- $R_4$ : risk of loss of economic value.

To evaluate risks,  $R$ , the relevant risk components (partial risks depending on the source and type of damage) shall be defined and calculated.

Each risk,  $R$ , is the sum of its risk components. When calculating a risk, the risk components may be grouped according to the source of damage and the type of damage.

#### 4.2.2 Risk components for a structure due to flashes to the structure

$R_A$ : Component related to injury to living beings caused by electric shock due to touch and step voltages inside the structure and outside in the zones up to 3 m around down-conductors. Loss of type L1 and, in the case of structures holding livestock, loss of type L4 with possible loss of animals may also arise.

NOTE In special structures, people may be endangered by direct strikes (e.g. top level of garage parking or stadiums). These cases may also be considered using the principles of this part of IEC 62305.

$R_B$ : Component related to physical damage caused by dangerous sparking inside the structure triggering fire or explosion which may also endanger the environment. All types of loss (L1, L2, L3 and L4) may arise.

$R_C$ : Component related to failure of internal systems caused by LEMP. Loss of type L2 and L4 could occur in all cases along with type L1 in the case of structures with risk of explosion, and hospitals or other structures where failure of internal systems immediately endangers human life.

#### 4.2.3 Risk component for a structure due to flashes near the structure

$R_M$ : Component related to failure of internal systems caused by LEMP. Loss of type L2 and L4 could occur in all cases, along with type L1 in the case of structures with risk of explosion, and hospitals or other structures where failure of internal systems immediately endangers human life.

#### 4.2.4 Risk components for a structure due to flashes to a line connected to the structure

$R_U$ : Component related to injury to living beings caused by electric shock due to touch voltage inside the structure. Loss of type L1 and, in the case of agricultural properties, losses of type L4 with possible loss of animals could also occur.

$R_V$ : Component related to physical damage (fire or explosion triggered by dangerous sparking between external installation and metallic parts generally at the entrance point of the line into the structure) due to lightning current transmitted through or along incoming lines. All types of loss (L1, L2, L3, L4) may occur.

$R_W$ : Component related to failure of internal systems caused by overvoltages induced on incoming lines and transmitted to the structure. Loss of type L2 and L4 could occur in all cases, along with type L1 in the case of structures with risk of explosion, and hospitals or other structures where failure of internal systems immediately endangers human life.

NOTE 1 The lines taken into account in this assessment are only the lines entering the structure.

NOTE 2 Lightning flashes to or near pipes are not considered as a source of damage based on the bonding of pipes to an equipotential bonding bar. If an equipotential bonding bar is not provided, such a threat should also be considered.

#### 4.2.5 Risk component for a structure due to flashes near a line connected to the structure

$R_Z$ : Component related to failure of internal systems caused by overvoltages induced on incoming lines and transmitted to the structure. Loss of type L2 and L4 could occur in all cases, along with type L1 in the case of structures with risk of explosion, and hospitals or other structures where failure of internal systems immediately endanger human life.

NOTE 1 Lines taken into account in this assessment are only the lines entering the structure.

NOTE 2 Lightning flashes to or near pipes are not considered as a source of damage based on the bonding of pipes to an equipotential bonding bar. If an equipotential bonding bar is not provided, such a threat should also be considered.

### 4.3 Composition of risk components

Risk components to be considered for each type of loss in a structure are listed below:

$R_1$ : Risk of loss of human life:

$$R_1 = R_{A1} + R_{B1} + R_{C1}^{(1)} + R_{M1}^{(1)} + R_{U1} + R_{V1} + R_{W1}^{(1)} + R_{Z1}^{(1)} \quad (1)$$

<sup>1)</sup> Only for structures with risk of explosion and for hospitals with life-saving electrical equipment or other structures when failure of internal systems immediately endangers human life.

$R_2$ : Risk of loss of service to the public:

$$R_2 = R_{B2} + R_{C2} + R_{M2} + R_{V2} + R_{W2} + R_{Z2} \quad (2)$$

$R_3$ : Risk of loss of cultural heritage:

$$R_3 = R_{B3} + R_{V3} \quad (3)$$

$R_4$ : Risk of loss of economic value:

$$R_4 = R_{A4}^{(2)} + R_{B4} + R_{C4} + R_{M4} + R_{U4}^{(2)} + R_{V4} + R_{W4} + R_{Z4} \quad (4)$$

<sup>2)</sup> Only for properties where animals may be lost.

The risk components corresponding to each type of loss are also combined in Table 2.

**Table 2 – Risk components to be considered for each type of loss in a structure**

Source of damage	Flash to a structure S1			Flash near a structure S2	Flash to a line connected to the structure S3			Flash near a line connected to the structure S4
	$R_A$	$R_B$	$R_C$	$R_M$	$R_U$	$R_V$	$R_W$	$R_Z$
Risk for each type of loss								
$R_1$	*	*	* a	* a	*	*	* a	* a
$R_2$		*	*	*		*	*	*
$R_3$		*				*		
$R_4$	* b	*	*	*	* b	*	*	*

<sup>a</sup> Only for structures with risk of explosion, and for hospitals or other structures where failure of internal systems immediately endangers human life.

<sup>b</sup> Only for properties where animals may be lost.

Characteristics of the structure and of possible protection measures influencing risk components for a structure are given in Table 3.

**Table 3 – Factors influencing the risk components**

Characteristics of structure or of internal systems Protection measures	$R_A$	$R_B$	$R_C$	$R_M$	$R_U$	$R_V$	$R_W$	$R_Z$
Collection area	X	X	X	X	X	X	X	X
Surface soil resistivity	X							
Floor resistivity	X				X			
Physical restrictions, insulation, warning notice, soil equipotentialization	X				X			
LPS	X	X	X	X <sup>a</sup>	X <sup>b</sup>	X <sup>b</sup>		
Bonding SPD	X	X			X	X		
Isolating interfaces			X <sup>c</sup>	X <sup>c</sup>	X	X	X	X
Coordinated SPD system			X	X			X	X
Spatial shield			X	X				
Shielding external lines					X	X	X	X
Shielding internal lines			X	X				
Routing precautions			X	X				
Bonding network			X					
Fire precautions		X				X		
Fire sensitivity		X				X		
Special hazard		X				X		
Impulse withstand voltage			X	X	X	X	X	X
<sup>a</sup> Only for grid-like external LPS. <sup>b</sup> Due to equipotential bonding. <sup>c</sup> Only if they belong to equipment.								

## 5 Risk management

### 5.1 Basic procedure

The following procedure shall be applied:

- identification of the structure to be protected and its characteristics;
- identification of all the types of loss in the structure and the relevant corresponding risk  $R$  ( $R_1$  to  $R_4$ );
- evaluation of risk  $R$  for each type of loss  $R_1$  to  $R_4$ ;
- evaluation of need of protection, by comparison of risk  $R_1$ ,  $R_2$  and  $R_3$  with the tolerable risk  $R_T$ ;
- evaluation of cost effectiveness of protection by comparison of the costs of total loss with and without protection measures. In this case, the assessment of components of risk  $R_4$  shall be performed in order to evaluate such costs (see Annex D).

### 5.2 Structure to be considered for risk assessment

The structure to be considered includes:

- the structure itself;
- installations in the structure;

- contents of the structure;
- persons in the structure or in the zones up to 3 m from the outside of the structure;
- environment affected by damage to the structure.

Protection does not include connected lines outside of the structure.

NOTE The structure to be considered may be subdivided into several zones (see 6.7).

### 5.3 Tolerable risk $R_T$

It is the responsibility of the authority having jurisdiction to identify the value of tolerable risk.

Representative values of tolerable risk  $R_T$ , where lightning flashes involve loss of human life or loss of social or cultural values, are given in Table 4.

**Table 4 – Typical values of tolerable risk  $R_T$**

Types of loss		$R_T$ ( $y^{-1}$ )
L1	Loss of human life or permanent injuries	$10^{-5}$
L2	Loss of service to the public	$10^{-3}$
L3	Loss of cultural heritage	$10^{-4}$

In principle, for loss of economic value (L4), the route to be followed is the cost/benefit comparison given in Annex D. If the data for this analysis are not available the representative value of tolerable risk  $R_T = 10^{-3}$  may be used.

### 5.4 Specific procedure to evaluate the need of protection

According to IEC 62305-1, risks  $R_1$ ,  $R_2$  and  $R_3$  shall be considered in the evaluation of the need of protection against lightning.

For each risk to be considered the following steps shall be taken:

- identification of the components  $R_X$  which make up the risk;
- calculation of the identified risk components  $R_X$ ;
- calculation of the total risk  $R$  (see 4.3);
- identification of the tolerable risk  $R_T$ ;
- comparison of the risk  $R$  with the tolerable value  $R_T$ .

If  $R \leq R_T$ , lightning protection is not necessary.

If  $R > R_T$ , protection measures shall be adopted in order to reduce  $R \leq R_T$  for all risks to which the structure is subjected.

The procedure to evaluate the need for protection is given in Figure 1.

NOTE 1 In cases where the risk cannot be reduced to a tolerable level, the site owner should be informed and the highest level of protection provided to the installation.

NOTE 2 Where protection against lightning is required by the authority having jurisdiction for structures with a risk of explosion, at least a class II LPS should be adopted. Exceptions to the use of lightning protection level II may be allowed when technically justified and authorized by the authority having jurisdiction. For example, the use of lightning protection level I is allowed in all cases, especially in those cases where the environments or contents within the structure are exceptionally sensitive to the effects of lightning. In addition, authorities having jurisdiction may choose to allow lightning protection level III systems where the infrequency of lightning activity and/or the insensitivity of the contents of the structure warrants it.



NOTE 3 When the damage to a structure due to lightning may also involve surrounding structures or the environment (e.g. chemical or radioactive emissions), additional protection measures for the structure and measures appropriate for these zones may be requested by the authorities having jurisdiction.

### 5.5 Procedure to evaluate the cost effectiveness of protection

Besides the need for lightning protection of a structure, it may be useful to ascertain the economic benefits of installing protection measures in order to reduce the economic loss L4.

The assessment of components of risk  $R_4$  allows the user to evaluate the cost of the economic loss with and without the adopted protection measures (see Annex D).

The procedure to ascertain the cost effectiveness of protection requires:

- identification of the components  $R_X$  which make up the risk  $R_4$ ;
- calculation of the identified risk components  $R_X$  in absence of new/additional protection measures;
- calculation of the annual cost of loss due to each risk component  $R_X$ ;
- calculation of the annual cost  $C_L$  of total loss in the absence of protection measures;
- adoption of selected protection measures;
- calculation of risk components  $R_X$  with selected protection measures present;
- calculation of the annual cost of residual loss due to each risk component  $R_X$  in the protected structure;
- calculation of the total annual cost  $C_{RL}$  of residual loss with selected protection measures present;
- calculation of the annual cost  $C_{PM}$  of selected protection measures;
- comparison of costs.

If  $C_L < C_{RL} + C_{PM}$ , lightning protection may be deemed not to be cost effective.

If  $C_L \geq C_{RL} + C_{PM}$ , protection measures may prove to save money over the life of the structure.

The procedure to evaluate the cost-effectiveness of protection is outlined in Figure 2.

It may be useful to evaluate some variants of combination of protection measures to find the optimal solution regarding the cost effectiveness.

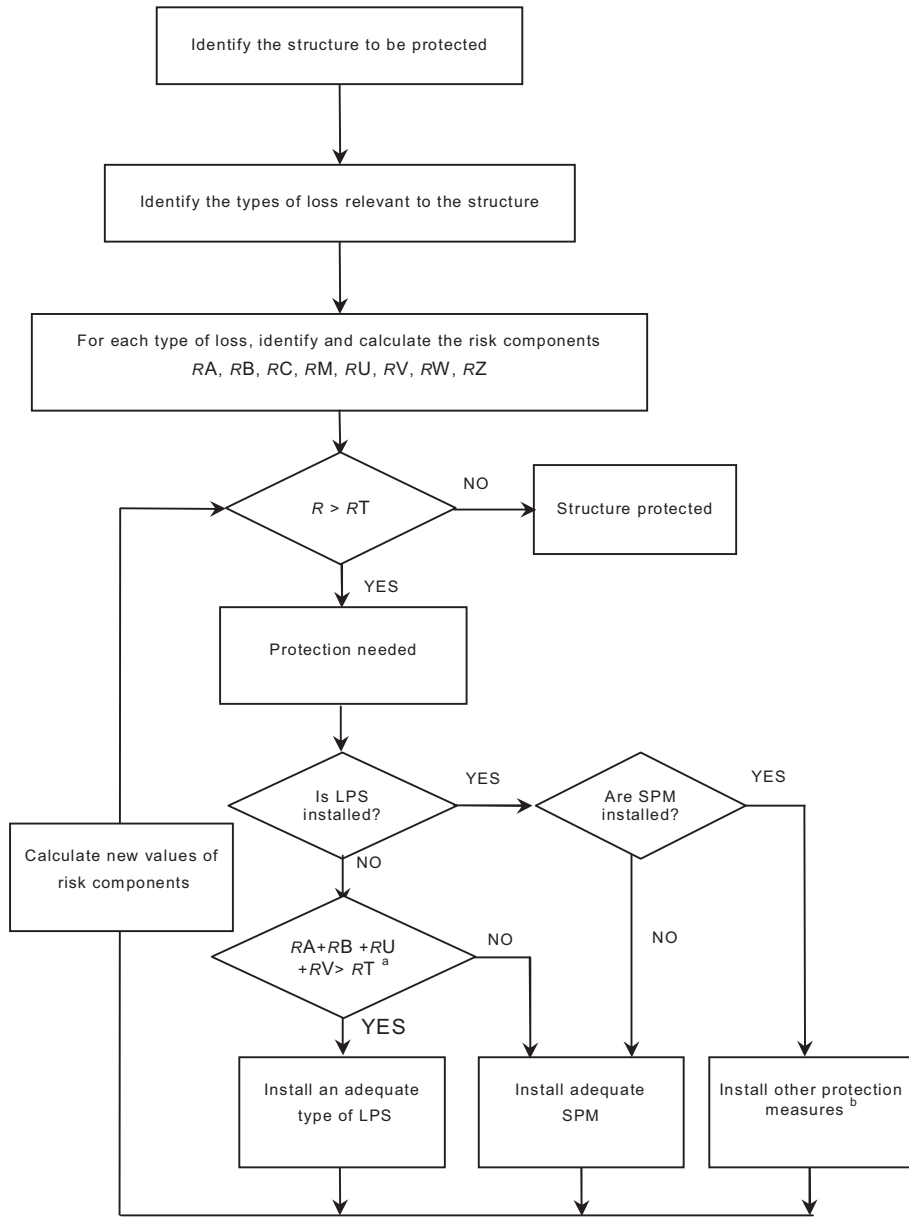

IEC 2635/10

<sup>a</sup> If  $R_A + R_B < R_T$ , a complete LPS is not necessary; in this case SPD(s) according to IEC 62305-3 are sufficient.

<sup>b</sup> See Table 3.

**Figure 1 – Procedure for deciding the need of protection and for selecting protection measures**

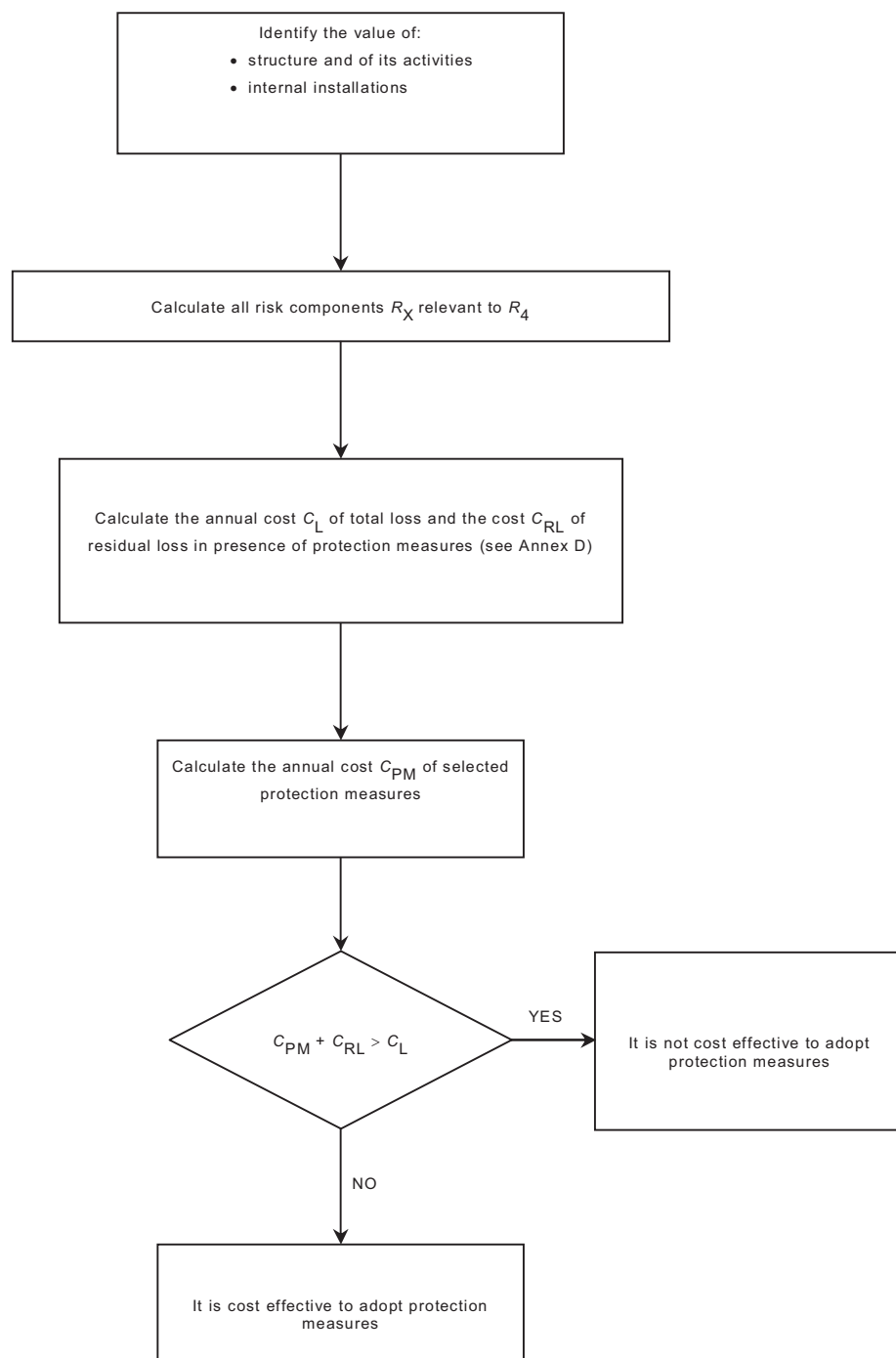

IEC 2636/10

**Figure 2 – Procedure for evaluating the cost-effectiveness of protection measures**

## 5.6 Protection measures

Protection measures are directed to reducing the risk according to the type of damage.

Protection measures shall be considered effective only if they conform to the requirements of the following relevant standards:

- IEC 62305-3 for protection against injury to living beings and physical damage in a structure;
- IEC 62305-4 for protection against failure of electrical and electronic systems.

## 5.7 Selection of protection measures

The selection of the most suitable protection measures shall be made by the designer according to the share of each risk component in the total risk  $R$  and according to the technical and economic aspects of the different protection measures.

Critical parameters shall be identified to determine the more efficient measure to reduce the risk  $R$ .

For each type of loss, there is a number of protection measures which, individually or in combination, make the condition  $R \leq R_T$ . The solution to be adopted shall be selected with allowance for technical and economic aspects. A simplified procedure for selection of protective measures is given in the flow diagram of Figure 1. In any case, the installer or planner should identify the most critical risk components and reduce them, also taking into account economic aspects.

## 6 Assessment of risk components

### 6.1 Basic equation

Each risk component  $R_A$ ,  $R_B$ ,  $R_C$ ,  $R_M$ ,  $R_U$ ,  $R_V$ ,  $R_W$  and  $R_Z$ , as described in 4.2.2, 4.2.3, 4.2.4 and 4.2.5 may be expressed by the following general equation:

$$R_X = N_X \times P_X \times L_X \quad (5)$$

where

$N_X$  is the number of dangerous events per annum (see also Annex A);

$P_X$  is the probability of damage to a structure (see also Annex B);

$L_X$  is the consequent loss (see also Annex C).

The number  $N_X$  of dangerous events is affected by lightning ground flash density ( $N_G$ ) and by the physical characteristics of the structure to be protected, its surroundings, connected lines and the soil.

The probability of damage  $P_X$  is affected by characteristics of the structure to be protected, the connected lines and the protection measures provided.

The consequent loss  $L_X$  is affected by the use to which the structure is assigned, the attendance of persons, the type of service provided to public, the value of goods affected by the damage and the measures provided to limit the amount of loss.

NOTE When the damage to a structure due to lightning may also involve surrounding structures or the environment (e.g. chemical or radioactive emissions), the consequent loss should be added to the value of  $L_X$ .

### 6.2 Assessment of risk components due to flashes to the structure (S1)

For evaluation of risk components related to lightning flashes to the structure, the following relationships apply:

- component related to injury to living beings by electric shock (D1)

$$R_A = N_D \times P_A \times L_A \quad (6)$$

- component related to physical damage (D2)

$$R_B = N_D \times P_B \times L_B \quad (7)$$

- component related to failure of internal systems (D3)

$$R_C = N_D \times P_C \times L_C \quad (8)$$

Parameters to assess these risk components are given in Table 5.

### 6.3 Assessment of the risk component due to flashes near the structure (S2)

For evaluation of the risk component related to lightning flashes near the structure, the following relationship applies:

- component related to failure of internal systems (D3)

$$R_M = N_M \times P_M \times L_M \quad (9)$$

Parameters to assess this risk component are given in Table 5.

### 6.4 Assessment of risk components due to flashes to a line connected to the structure (S3)

For evaluation of the risk components related to lightning flashes to an incoming line, the following relationships apply:

- component related to injury to living beings by electric shock (D1)

$$R_U = (N_L + N_{DJ}) \times P_U \times L_U \quad (10)$$

- component related to physical damage (D2)

$$R_V = (N_L + N_{DJ}) \times P_V \times L_V \quad (11)$$

- component related to failure of internal systems (D3)

$$R_W = (N_L + N_{DJ}) \times P_W \times L_W \quad (12)$$

NOTE 1 In many cases  $N_{DJ}$  may be neglected.

Parameters to assess these risk components are given in Table 5.

If the line has more than one section (see 6.8), the values of  $R_U$ ,  $R_V$  and  $R_W$  are the sum of the  $R_U$ ,  $R_V$  and  $R_W$  values relevant to each section of the line. The sections to be considered are those between the structure and the first node.

In the case of a structure with more than one connected line with different routing, the calculations shall be performed for each line.

In the case of a structure with more than one connected line with the same routing, the calculations shall be performed only for the line with the worst characteristics, i.e. the line with the highest values of  $N_L$  and  $N_I$  connected to the internal system with the lowest value of  $U_W$  (telecom line versus power line, unscreened line versus screened line, LV power line versus HV power line with HV/LV transformer, etc.).

NOTE 2 In the case of lines for which there is an overlapping of the collection area, the overlapping area should be considered only once.

### 6.5 Assessment of risk component due to flashes near a line connected to the structure (S4)

For evaluation of the risk component related to lightning flashes near a line connected to the structure, the following relationship applies:

- component related to failure of internal systems (D3)

$$R_Z = N_I \times P_Z \times L_Z \tag{13}$$

Parameters to assess this risk component are given in Table 5.

If the line has more than one section (see 6.8), the value of  $R_Z$  is the sum of the  $R_Z$  components relevant to each section of the line. The sections to be considered are those between the structure and the first node.

**Table 5 – Parameters relevant to the assessment of risk components**

Symbol	Denomination	Value according to clause
<b>Average annual number of dangerous events due to flashes</b>		
$N_D$	– to the structure	A.2
$N_M$	– near the structure	A.3
$N_L$	– to a line entering the structure	A.4
$N_I$	– near a line entering the structure	A.5
$N_{DJ}$	– to the adjacent structure (see Figure A.5)	A.2
<b>Probability that a flash to the structure will cause</b>		
$P_A$	– injury to living beings by electric shock	B.2
$P_B$	– physical damage	B.3
$P_C$	– failure of internal systems	B.4
<b>Probability that a flash near the structure will cause</b>		
$P_M$	– failure of internal systems	B.5
<b>Probability that a flash to a line will cause</b>		
$P_U$	– injury to living beings by electric shock	B.6
$P_V$	– physical damage	B.7
$P_W$	– failure of internal systems	B.8
<b>Probability that a flash near a line will cause</b>		
$P_Z$	– failure of internal systems	B.9
<b>Loss due to</b>		
$L_A = L_U$	– injury to living beings by electric shock	C.3
$L_B = L_V$	– physical damage	C.3, C.4, C.5, C.6
$L_C = L_M = L_W = L_Z$	– failure of internal systems	C.3, C.4, C.6

In the case of a structure with more than one connected line with different routing, the calculations shall be performed for each line.

In the case of a structure with more than one connected line with the same routing, the calculations shall be performed only for the line with the worst characteristics, i.e. the line with the highest values of  $N_L$  and  $N_I$  connected to the internal system with the lowest value of  $U_W$  (telecom line versus power line, unscreened line versus screened line, LV power line versus HV power line with HV/LV transformer, etc.)

## 6.6 Summary of risk components

Risk components for structures are summarized in Table 6 according to different types of damage and different sources of damage.

**Table 6 – Risk components for different types of damage and source of damage**

Damage	Source of damage			
	S1 Lightning flash to a structure	S2 Lightning flash near a structure	S3 Lightning flash to an incoming line	S4 Lightning flash near a line
D1 Injury to living beings by electric shock	$R_A = N_D \times P_A \times L_A$		$R_U = (N_L + N_{DJ}) \times P_U \times L_U$	
D2 Physical damage	$R_B = N_D \times P_B \times L_B$		$R_V = (N_L + N_{DJ}) \times P_V \times L_V$	
D3 Failure of electrical and electronic systems	$R_C = N_D \times P_C \times L_C$	$R_M = N_M \times P_M \times L_M$	$R_W = (N_L + N_{DJ}) \times P_W \times L_W$	$R_Z = N_I \times P_Z \times L_Z$

If the structure is partitioned in zones  $Z_S$  (see 6.7), each risk component shall be evaluated for each zone  $Z_S$ .

The total risk  $R$  of the structure is the sum of risks components relevant to the zones  $Z_S$  which constitute the structure.

## 6.7 Partitioning of a structure in zones $Z_S$

To assess each risk component, a structure could be divided into zones  $Z_S$  each having homogeneous characteristics. However, a structure may be, or may be assumed to be, a single zone.

Zones  $Z_S$  are mainly defined by:

- type of soil or of floor (risk components  $R_A$  and  $R_U$ );
- fireproof compartments (risk components  $R_B$  and  $R_V$ );
- spatial shields (risk components  $R_C$  and  $R_M$ ).

Further zones may be defined according to

- layout of internal systems (risk components  $R_C$  and  $R_M$ ),
- protection measures existing or to be provided (all risk components),
- losses  $L_X$  values (all risk components).

Partitioning of the structure in zones  $Z_S$  should take into account the feasibility of the implementation of the most suitable protection measures.

NOTE Zones  $Z_S$  according to this part of IEC 62305 may be LPZ in line with IEC 62305-4. However they may also be different from LPZs.

## 6.8 Partitioning of a line into sections $S_L$

To assess the risk components due to a flash to or near a line, the line could be divided into sections  $S_L$ . However a line may be, or may be assumed to be, a single section.

For all risk components, sections  $S_L$  are mainly defined by

- type of line (aerial or buried),
- factors affecting the collection area ( $C_D$ ,  $C_E$ ,  $C_T$ ),
- characteristics of line (shielded or unshielded, shield resistance).

If more than one value of a parameter exists in a section, the value leading to the highest value of risk is to be assumed.

## 6.9 Assessment of risk components in a structure with zones $Z_S$

### 6.9.1 General criteria

For the evaluation of risk components and the selection of the relevant parameters involved, the following rules apply:

- parameters relevant to the number  $N$  of dangerous events shall be evaluated according to Annex A;
- parameters relevant to the probability  $P$  of damage shall be evaluated according to Annex B.

Moreover:

- for components  $R_A$ ,  $R_B$ ,  $R_U$ ,  $R_V$ ,  $R_W$  and  $R_Z$ , only one value is to be fixed in each zone for each parameter involved. Where more than one value is applicable, the highest one shall be chosen.
- for components  $R_C$  and  $R_M$ , if more than one internal system is involved in a zone, values of  $P_C$  and  $P_M$  are given by:

$$P_C = 1 - (1 - P_{C1}) \times (1 - P_{C2}) \times (1 - P_{C3}) \quad (14)$$

$$P_M = 1 - (1 - P_{M1}) \times (1 - P_{M2}) \times (1 - P_{M3}) \quad (15)$$

where  $P_{Ci}$ , and  $P_{Mi}$  are parameters relevant to internal system  $i = 1, 2, 3, \dots$

- parameters relevant to the amount  $L$  of loss shall be evaluated according to Annex C.

With the exception made for  $P_C$  and  $P_M$ , if more than one value of any other parameter exists in a zone, the value of the parameter leading to the highest value of risk is to be assumed.

### 6.9.2 Single zone structure

In this case only one zone  $Z_S$  made up of the entire structure is defined. The risk  $R$  is the sum of risk components  $R_X$  in this zone.

Defining the structure with a single zone may lead to expensive protection measures because each measure must extend to the entire structure.

### 6.9.3 Multi-zone structure

In this case, the structure is divided into multiple zones  $Z_S$ . The risk for the structure is the sum of the risks relevant to all zones of the structure; in each zone, the risk is the sum of all relevant risk components in the zone.



Dividing a structure into zones allows the designer to take into account the characteristics of each part of the structure in the evaluation of risk components and to select the most suitable protection measures tailored zone by zone, reducing the overall cost of protection against lightning.

#### **6.10 Cost-benefit analysis for economic loss (L4)**

Whether or not there is need to determine protection to reduce risks  $R_1$ ,  $R_2$ , and  $R_3$ , it is useful to evaluate the economic justification in adopting protection measures in order to reduce the risk  $R_4$  of economic loss.

The items for which the assessment of risk  $R_4$  is to be performed shall be defined from

- the whole structure,
- a part of the structure,
- an internal installation,
- a part of an internal installation,
- a piece of equipment,
- the contents in the structure.

The cost of loss, the cost of the protection measures and the possible saving should be evaluated according to Annex D. If the data for this analysis are not available the representative value of tolerable risk  $R_T = 10^{-3}$  may be used.

## Annex A (informative)

### Assessment of annual number $N$ of dangerous events

#### A.1 General

The average annual number  $N$  of dangerous events due to lightning flashes influencing a structure to be protected depends on the thunderstorm activity of the region where the structure is located and on the structure's physical characteristics. To calculate the number  $N$ , one should multiply the lightning ground flash density  $N_G$  by an equivalent collection area of the structure, taking into account correction factors for the structure's physical characteristics.

The lightning ground flash density  $N_G$  is the number of lightning flashes per km<sup>2</sup> per year. This value is available from ground flash location networks in many areas of the world.

NOTE If a map of  $N_G$  is not available, in temperate regions it may be estimated by:

$$N_G \approx 0,1 T_D \quad (\text{A.1})$$

where  $T_D$  is the thunderstorm days per year (which can be obtained from isokeraunic maps).

Events that may be considered as dangerous for a structure to be protected are

- flashes to the structure,
- flashes near the structure,
- flashes to a line entering the structure,
- flashes near a line entering the structure,
- flashes to a another structure to which a line is connected.

#### A.2 Assessment of the average annual number of dangerous events $N_D$ due to flashes to a structure and $N_{DJ}$ to an adjacent structure

##### A.2.1 Determination of the collection area $A_D$

For isolated structures on flat ground, the collection area  $A_D$  is the area defined by the intersection between the ground surface and a straight line with 1/3 slope which passes from the upper parts of the structure (touching it there) and rotating around it. Determination of the value of  $A_D$  may be performed graphically or mathematically.

##### A.2.1.1 Rectangular structure

For an isolated rectangular structure with length  $L$ , width  $W$ , and height  $H$  on flat ground, the collection area is then equal to:

$$A_D = L \times W + 2 \times (3 \times H) \times (L + W) + \pi \times (3 \times H)^2 \quad (\text{A.2})$$

where  $L$ ,  $W$  and  $H$  are expressed in metres (see Figure A.1).

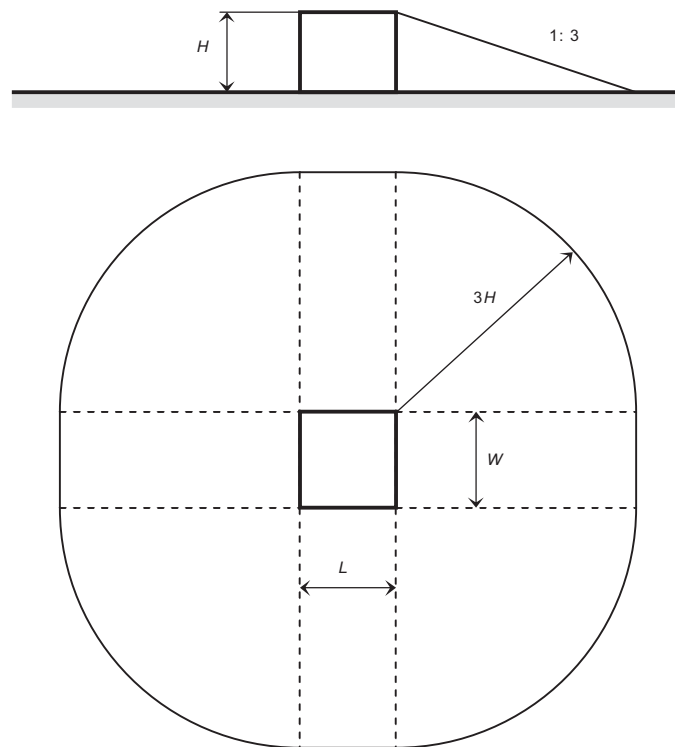

IEC 2637/10

**Figure A.1 – Collection area  $A_D$  of an isolated structure**

### A.2.1.2 Complex shaped structure

If the structure has a complex shape such as elevated roof protrusions (see Figure A.2), a graphical method should be used to evaluate  $A_D$  (see Figure A.3).

An acceptable approximate value of the collection area is the greater between the collection area  $A_{D_{MIN}}$  evaluated with Equation (A.2) taking the minimum height  $H_{MIN}$  of the structure, and the collection area attributed to the elevated roof protrusion  $A_{D'}$ .  $A_{D'}$  may be calculated by:

$$A_{D'} = \pi \times (3 \times H_p)^2 \quad (\text{A.3})$$

where  $H_p$  is the height of protrusion.

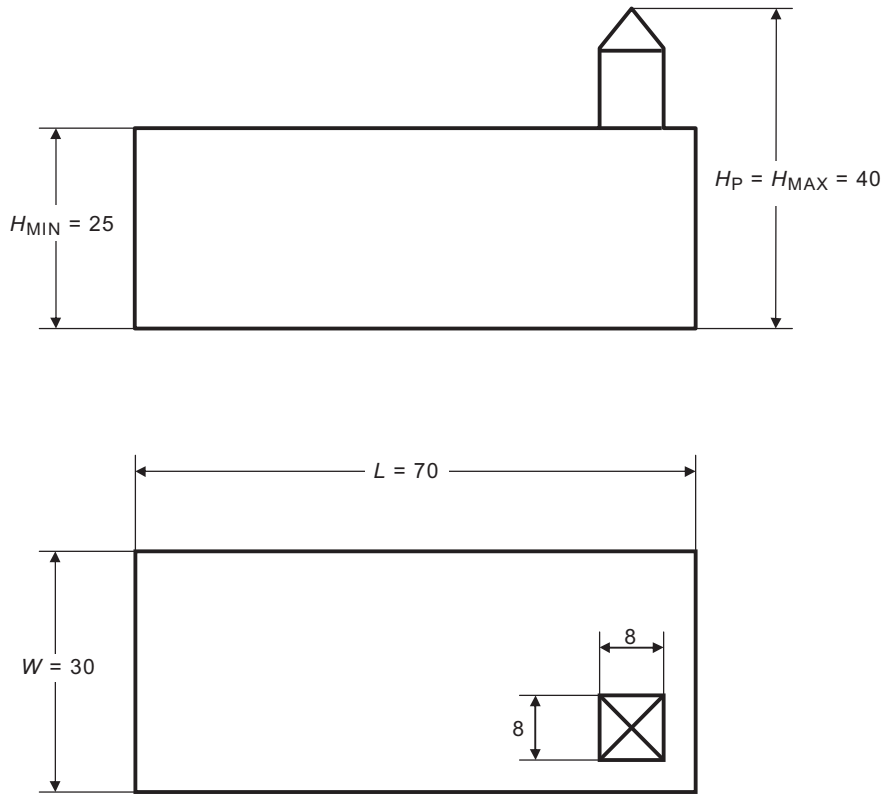

IEC 2638/10

Figure A.2 – Complex shaped structure

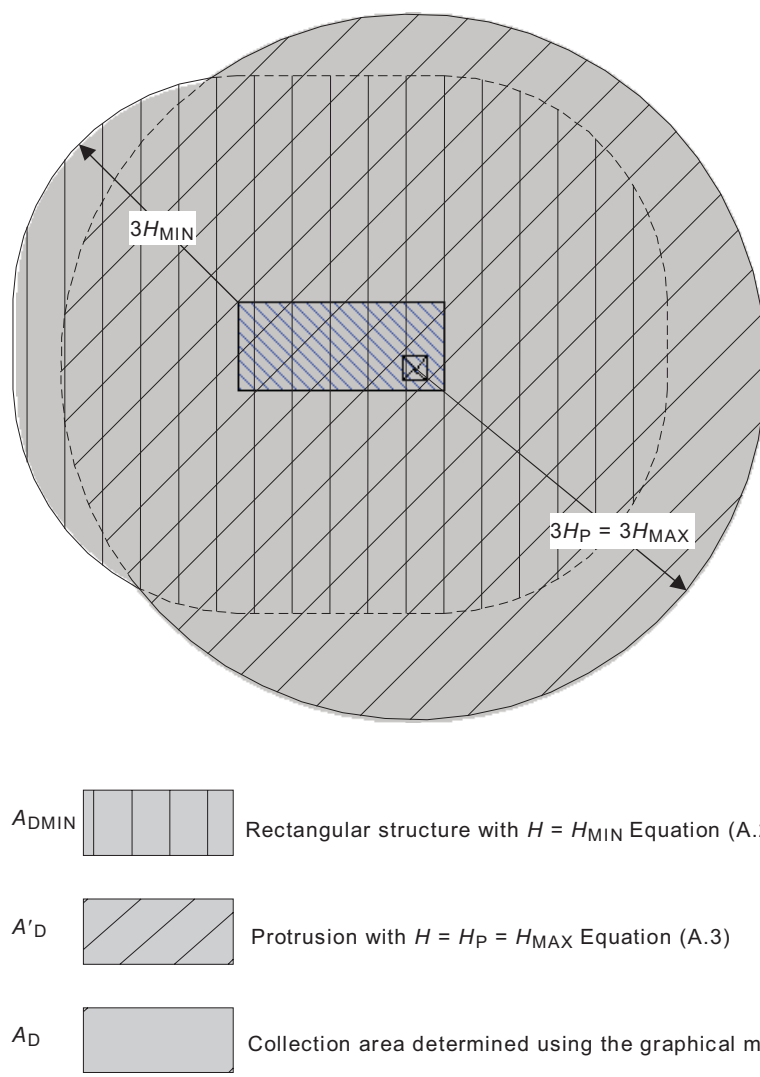

**Figure A.3 – Different methods to determine the collection area for the given structure**

### A.2.2 Structure as a part of a building

Where the structure  $S$  to be considered consists of only a part of a building  $B$ , the dimensions of structure  $S$  may be used in evaluation of  $A_D$  provided that the following conditions are fulfilled (see Figure A.4):

- the structure  $S$  is a separated vertical part of the building  $B$ ;
- the building  $B$  does not have a risk of explosion;
- propagation of fire between the structure  $S$  and other parts of the building  $B$  is avoided by means of walls with resistance to fire of 120 min (REI 120) or by means of other equivalent protection measures;
- propagation of overvoltages along common lines, if any, is avoided by means of SPDs installed at the entrance point of such lines in the structure or by means of other equivalent protection measure.

NOTE For definition and information on REI, see [6].

Where these conditions are not fulfilled, the dimensions of the whole building  $B$  should be used.

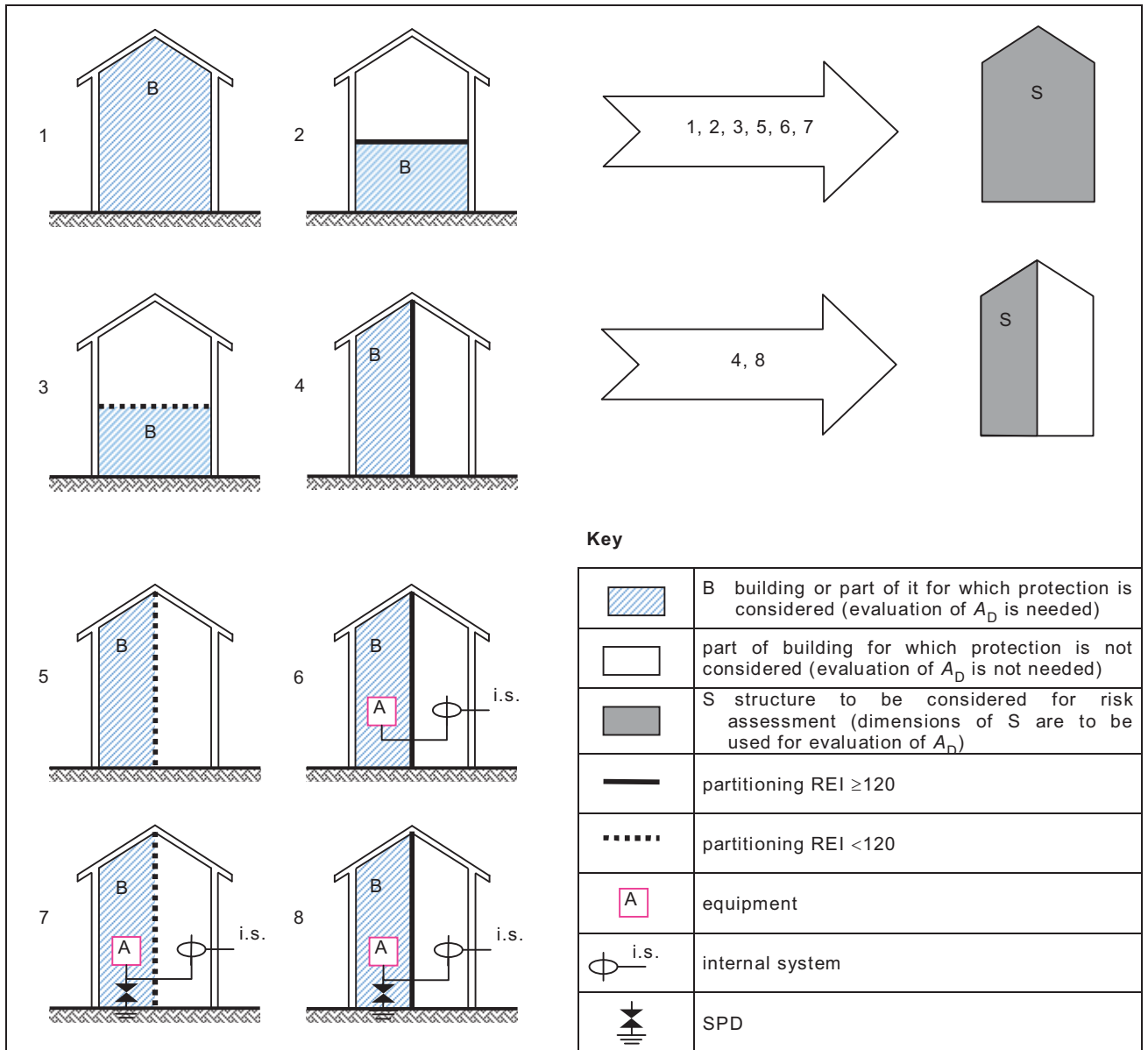

IEC 2640/10

Figure A.4 – Structure to be considered for evaluation of collection area  $A_D$

### A.2.3 Relative location of the structure

The relative location of the structure, compensating for surrounding structures or an exposed location, will be taken into account by a location factor  $C_D$  (see Table A.1).

A more precise evaluation of the surrounding objects' influence can be obtained considering the relative height of the structure with respect to the surrounding objects or the ground within a distance of  $3 \times H$  from the structure and assuming  $C_D = 1$ .

**Table A.1 – Structure location factor  $C_D$** 

Relative location	$C_D$
Structure surrounded by higher objects	0,25
Structure surrounded by objects of the same height or smaller	0,5
Isolated structure: no other objects in the vicinity	1
Isolated structure on a hilltop or a knoll	2

**A.2.4 Number of dangerous events  $N_D$  for the structure**

$N_D$  may be evaluated as the product:

$$N_D = N_G \times A_D \times C_D \times 10^{-6} \quad (\text{A.4})$$

where

$N_G$  is the lightning ground flash density ( $1/\text{km}^2 \times \text{year}$ );

$A_D$  is the collection area of the structure ( $\text{m}^2$ ) (see Figure A.5);

$C_D$  is the location factor of the structure (see Table A.1).

**A.2.5 Number of dangerous events  $N_{DJ}$  for an adjacent structure**

The average annual number of dangerous events due to flashes to a structure connected at the far end of a line,  $N_{DJ}$  (see 6.5 and Figure A.5) may be evaluated as the product:

$$N_{DJ} = N_G \times A_{DJ} \times C_{DJ} \times C_T \times 10^{-6} \quad (\text{A.5})$$

where

$N_G$  is the lightning ground flash density ( $1/\text{km}^2 \times \text{year}$ );

$A_{DJ}$  is the collection area of the adjacent structure ( $\text{m}^2$ ) (see Figure A.5);

$C_{DJ}$  is the location factor of the adjacent structure (see Table A.1);

$C_T$  is the line type factor (see Table A.3);

**A.3 Assessment of the average annual number of dangerous events  $N_M$  due to flashes near a structure**

$N_M$  may be evaluated as the product:

$$N_M = N_G \times A_M \times 10^{-6} \quad (\text{A.6})$$

where

$N_G$  is the lightning ground flash density ( $1/\text{km}^2 \times \text{year}$ );

$A_M$  is the collection area of flashes striking near the structure ( $\text{m}^2$ ).

The collection area  $A_M$  extends to a line located at a distance of 500 m from the perimeter of the structure (see Figure A.5):

$$A_M = 2 \times 500 \times (L + W) + \pi \times 500^2 \quad (\text{A.7})$$

#### A.4 Assessment of the average annual number of dangerous events $N_L$ due to flashes to a line

A line may consist of several sections. For each section of line, the value of  $N_L$  may be evaluated by:

$$N_L = N_G \times A_L \times C_I \times C_E \times C_T \times 10^{-6} \quad (\text{A.8})$$

where

$N_L$  is the number of overvoltages of amplitude not lower than 1 kV (1/year) on the line section)

$N_G$  is the lightning ground flash density ( $1/\text{km}^2 \times \text{year}$ );

$A_L$  is the collection area of flashes striking the line ( $\text{m}^2$ ) (see Figure A.5);

$C_I$  is the installation factor of the line (see Table A.2);

$C_T$  is the line type factor (see Table A.3);

$C_E$  is the environmental factor (see Table A.4);

with the collection area for flashes to a line:

$$A_L = 40 \times L_L \quad (\text{A.9})$$

$L_L$  is the length of the line section (m).

Where the length of a line section is unknown,  $L_L = 1\ 000$  m is to be assumed.

NOTE 1 National committees may improve this information in order to better meet national conditions of power and telecommunication lines.

**Table A.2 – Line installation factor  $C_I$**

Routing	$C_I$
Aerial	1
Buried	0,5
Buried cables running entirely within a meshed earth termination (5.2 of IEC 62305-4:2010).	0,01

**Table A.3 – Line type factor  $C_T$**

Installation	$C_T$
LV power, telecommunication or data line	1
HV power (with HV/LV transformer)	0,2

**Table A.4 – Line environmental factor  $C_E$**

Environment	$C_E$
Rural	1
Suburban	0,5
Urban	0,1
Urban with tall buildings <sup>a</sup>	0,01
<sup>a</sup> Buildings higher than 20 m.	



NOTE 2 The ground resistivity affects the collection area  $A_L$  of buried sections. In general, the larger the ground resistivity, the larger the collection area ( $A_L$  proportional to  $\sqrt{\rho}$ ). The installation factor of Table A.2 is based on  $\rho = 400 \Omega\text{m}$ .

NOTE 3 More information on the collection areas  $A_I$  for telecommunication lines can be found in ITU-T Recommendation K.47<sup>[7]</sup>.

### A.5 Assessment of average annual number of dangerous events $N_I$ due to flashes near a line

A line may consist of several sections. For each section of line, the value of  $N_I$  may be evaluated by

$$N_I = N_G \times A_I \times C_I \times C_E \times C_T \times 10^{-6} \quad (\text{A.10})$$

where

$N_I$  is the number of overvoltages of amplitude not lower than 1 kV (1/year) on the line section;

$N_G$  is the lightning ground flash density ( $1/\text{km}^2 \times \text{year}$ );

$A_I$  is the collection area of flashes to ground near the line ( $\text{m}^2$ ) (see Figure A.5);

$C_I$  is the installation factor (see Table A.2);

$C_T$  is the line type factor (see Table A.3);

$C_E$  is the environmental factor (see Table A.4).

with the collection area for flashes near a line

$$A_I = 4\,000 \times L_L \quad (\text{A.11})$$

where  $L_L$  is the length of the line section (m).

Where the length of a line section is unknown,  $L_L = 1\,000 \text{ m}$  is to be assumed.

NOTE 1 National committees can improve this information in order to better meet national conditions of power and telecommunication lines.

NOTE 2 A more precise evaluation of  $A_I$  can be found in Electra n. 161<sup>[8]</sup> and 162<sup>[9]</sup>, 1995 for power lines and in ITU-T Recommendation K.46<sup>[10]</sup> for telecommunications lines.

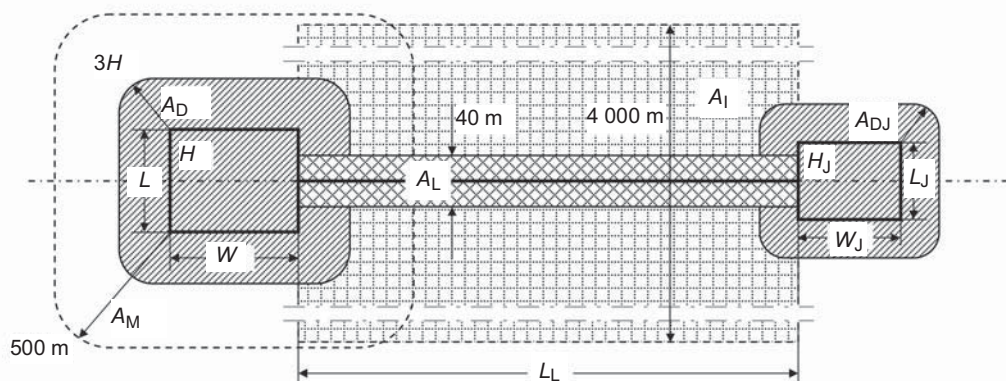

Figure A.5 – Collection areas ( $A_D$ ,  $A_M$ ,  $A_I$ ,  $A_L$ )

## Annex B (informative)

### Assessment of probability $P_X$ of damage

#### B.1 General

The probabilities given in this annex are valid if protection measures conform to:

- IEC 62305-3 for protection measures to reduce injury to living beings and for protection measures to reduce physical damage;
- IEC 62305-4 for protection measures to reduce failure of internal systems.

Other values may be chosen, if justified.

Values of probabilities  $P_X$  less than 1 may be selected only if the measure or characteristic is valid for the entire structure or zone of structure ( $Z_S$ ) to be protected and for all relevant equipment.

#### B.2 Probability $P_A$ that a flash to a structure will cause injury to living beings by electric shock

The values of probability  $P_A$  of shock to living beings due to touch and step voltage by a lightning flash to the structure, depend on the adopted LPS and on additional protection measures provided:

$$P_A = P_{TA} \times P_B \quad (\text{B.1})$$

where

$P_{TA}$  depends on additional protection measures against touch and step voltages, such as those listed in Table B.1. Values of  $P_{TA}$  are given in Table B.1.

$P_B$  depends on the lightning protection level (LPL) for which the LPS conforming to IEC 62305-3 is designed. Values of  $P_B$  are given in Table B.2.

**Table B.1 – Values of probability  $P_{TA}$  that a flash to a structure will cause shock to living beings due to dangerous touch and step voltages**

Additional protection measure	$P_{TA}$
No protection measures	1
Warning notices	$10^{-1}$
Electrical insulation (e.g. at least 3 mm cross-linked polyethylene) of exposed parts (e.g. down-conductors)	$10^{-2}$
Effective soil equipotentialization	$10^{-2}$
Physical restrictions or building framework used as a down-conductor system	0

If more than one provision has been taken, the value of  $P_{TA}$  is the product of the corresponding values.

NOTE 1 Protection measures are effective in reducing  $P_A$  only in structures protected by an LPS or structures with continuous metal or reinforced concrete framework acting as a natural LPS, where bonding and earthing requirements of IEC 62305-3 are satisfied.

NOTE 2 For more information see 8.1 and 8.2 of IEC 62305-3:2010.

### B.3 Probability $P_B$ that a flash to a structure will cause physical damage

An LPS is suitable as a protection measure to reduce  $P_B$ .

The values of probability  $P_B$  of physical damage by a flash to a structure, as a function of lightning protection level (LPL) are given in Table B.2.

**Table B.2 – Values of probability  $P_B$  depending on the protection measures to reduce physical damage**

Characteristics of structure	Class of LPS	$P_B$
Structure not protected by LPS	–	1
Structure protected by LPS	IV	0,2
	III	0,1
	II	0,05
	I	0,02
Structure with an air-termination system conforming to LPS I and a continuous metal or reinforced concrete framework acting as a natural down-conductor system		0,01
Structure with a metal roof and an air-termination system, possibly including natural components, with complete protection of any roof installations against direct lightning strikes and a continuous metal or reinforced concrete framework acting as a natural down-conductor system		0,001

NOTE 1 Values of  $P_B$  other than those given in Table B.2 are possible if based on a detailed investigation taking into account the requirements of sizing and interception criteria defined in IEC 62305-1.

NOTE 2 The characteristics of LPS, including those of SPD for lightning equipotential bonding, are reported in IEC 62305-3.

### B.4 Probability $P_C$ that a flash to a structure will cause failure of internal systems

A coordinated SPD system is suitable as a protection measure to reduce  $P_C$ .

The probability  $P_C$  that a flash to a structure will cause a failure of internal systems is given by:

$$P_C = P_{SPD} \times C_{LD} \quad (\text{B.2})$$

$P_{SPD}$  depends on the coordinated SPD system conforming to IEC 62305-4 and to the lightning protection level (LPL) for which its SPDs are designed. Values of  $P_{SPD}$  are given in Table B.3.

$C_{LD}$  is a factor depending on shielding, grounding and isolation conditions of the line to which the internal system is connected. Values of  $C_{LD}$  are given in Table B.4.

**Table B.3 – Value of the probability  $P_{SPD}$  as a function of LPL for which SPDs are designed**

LPL	$P_{SPD}$
No coordinated SPD system	1
III-IV	0,05
II	0,02
I	0,01
NOTE 2	0,005 – 0,001

NOTE 1 A coordinated SPD system is effective in reducing  $P_C$  only in structures protected by an LPS or structures with continuous metal or reinforced concrete framework acting as a natural LPS, where bonding and earthing requirements of IEC 62305-3 are satisfied.

NOTE 2 The values of  $P_{SPD}$  may be reduced for SPDs having better protection characteristics (higher nominal current  $I_N$ , lower protective level  $U_P$ , etc.) compared with the requirements defined for LPL I at the relevant installation locations (see Table A.3 of IEC 62305-1:2010 for information on lightning current probabilities, and Annex E of IEC 62305-1:2010 and Annex D of IEC 62305-4:2010 for lightning current sharing). The same annexes may be used for SPDs having higher probabilities  $P_{SPD}$ .

**Table B.4 – Values of factors  $C_{LD}$  and  $C_{LI}$  depending on shielding, grounding and isolation conditions**

External line type	Connection at entrance	$C_{LD}$	$C_{LI}$
Aerial line unshielded	Undefined	1	1
Buried line unshielded	Undefined	1	1
Multi grounded neutral power line	None	1	0,2
Shielded buried line (power or TLC)	Shield not bonded to the same bonding bar as equipment	1	0,3
Shielded aerial line (power or TLC)	Shield not bonded to the same bonding bar as equipment	1	0,1
Shielded buried line(power or TLC)	Shield bonded to the same bonding bar as equipment	1	0
Shielded aerial line (power or TLC)	Shield bonded to the same bonding bar as equipment	1	0
Lightning protective cable or wiring in lightning protective cable ducts, metallic conduit, or metallic tubes	Shield bonded to the same bonding bar as equipment	0	0
(No external line)	No connection to external lines (stand-alone systems)	0	0
Any type	Isolating interface according to IEC 62305-4	0	0

NOTE 3 In the evaluation of probability  $P_C$ , values of  $C_{LD}$  in Table B.4 refer to shielded internal systems; for unshielded internal systems,  $C_{LD} = 1$  should be assumed.

NOTE 4 For non-shielded internal systems

- not connected to external lines (stand-alone systems), or
- connected to external lines through isolating interfaces, or
- connected to external lines consisting of lightning protective cable or systems with wiring in lightning protective cable ducts, metallic conduit, or metallic tubes, bonded to the same bonding bar as equipment,

a coordinated SPD system according to IEC 62305-4 is not necessary to reduce  $P_C$ , provided that the induced voltage  $U_I$  is not higher than the withstand voltage  $U_W$  of the internal system ( $U_I \leq U_W$ ). For evaluation of induced voltage  $U_I$  see Annex A of IEC 62305-4:2010.

## B.5 Probability $P_M$ that a flash near a structure will cause failure of internal systems

A grid-like LPS, screening, routing precautions, increased withstand voltage, isolating interfaces and coordinated SPD systems are suitable as protection measures to reduce  $P_M$ .

The probability  $P_M$  that a lightning flash near a structure will cause failure of internal systems depends on the adopted SPM measures.

When a coordinated SPD system meeting the requirements of IEC 62305-4 is not provided, the value of  $P_M$  is equal to the value of  $P_{MS}$ .

When a coordinated SPD system according to IEC 62305-4 is provided, the value of  $P_M$  is given by:

$$P_M = P_{SPD} \times P_{MS} \quad (\text{B.3})$$

For internal systems with equipment not conforming to the resistibility or withstand voltage level given in the relevant product standards,  $P_M = 1$  should be assumed.

The values of  $P_{MS}$  are obtained from the product:

$$P_{MS} = (K_{S1} \times K_{S2} \times K_{S3} \times K_{S4})^2 \quad (\text{B.4})$$

where

$K_{S1}$  takes into account the screening effectiveness of the structure, LPS or other shields at boundary LPZ 0/1;

$K_{S2}$  takes into account the screening effectiveness of shields internal to the structure at boundary LPZ X/Y ( $X > 0$ ,  $Y > 1$ );

$K_{S3}$  takes into account the characteristics of internal wiring (see Table B.5);

$K_{S4}$  takes into account the impulse withstand voltage of the system to be protected.

NOTE 1 When equipment provided with isolating interfaces consisting of isolation transformers with earthed screen between windings, or of fibre optic cables or optical couplers is used,  $P_{MS} = 0$  should be assumed.

Inside an LPZ, at a safety distance from the boundary screen at least equal to the mesh width  $w_m$ , factors  $K_{S1}$  and  $K_{S2}$  for LPS or spatial grid-like shields may be evaluated as

$$K_{S1} = 0,12 \times w_{m1} \quad (\text{B.5})$$

$$K_{S2} = 0,12 \times w_{m2} \quad (\text{B.6})$$

where  $w_{m1}$  (m) and  $w_{m2}$  (m) are the mesh widths of grid-like spatial shields, or of mesh type LPS down-conductors or the spacing between the structure metal columns, or the spacing between a reinforced concrete framework acting as a natural LPS.

For continuous metal shields with thicknesses not lower than 0,1 mm,  $K_{S1} = K_{S2} = 10^{-4}$ .

NOTE 2 Where a meshed bonding network is provided according to IEC 62305-4, values of  $K_{S1}$  and  $K_{S2}$  may be halved.

Where the induction loop is running closely to the LPZ boundary screen conductors at a distance from the shield shorter than the safety distance, the values of  $K_{S1}$  and  $K_{S2}$  will be higher. For instance, the values of  $K_{S1}$  and  $K_{S2}$  should be doubled where the distance to the shield ranges from  $0,1 w_m$  to  $0,2 w_m$ .

For a cascade of LPZs the resulting  $K_{S2}$  is the product of the relevant  $K_{S2}$  of each LPZ.

NOTE 3 The maximum value of  $K_{S1}$  and  $K_{S2}$  is limited to 1.

**Table B.5 – Value of factor  $K_{S3}$  depending on internal wiring**

Type of internal wiring	$K_{S3}$
Unshielded cable – no routing precaution in order to avoid loops <sup>a</sup>	1
Unshielded cable – routing precaution in order to avoid large loops <sup>b</sup>	0,2
Unshielded cable – routing precaution in order to avoid loops <sup>c</sup>	0,01
Shielded cables and cables running in metal conduits <sup>d</sup>	0,0001
<sup>a</sup> Loop conductors with different routing in large buildings (loop area in the order of 50 m <sup>2</sup> ). <sup>b</sup> Loop conductors routed in the same conduit or loop conductors with different routing in small buildings (loop area in the order of 10 m <sup>2</sup> ). <sup>c</sup> Loop conductors routed in the same cable (loop area in the order of 0,5 m <sup>2</sup> ). <sup>d</sup> Shields and the metal conduits bonded to an equipotential bonding bar at both ends and equipment is connected to the same bonding bar.	

The factor  $K_{S4}$  is evaluated as:

$$K_{S4} = 1/U_W \tag{B.7}$$

where

$U_W$  is the rated impulse withstand voltage of system to be protected, in kV.

NOTE 4 The maximum value of  $K_{S4}$  is limited to 1.

If there is equipment with different impulse withstand levels in an internal system, the factor  $K_{S4}$  relevant to the lowest impulse withstand level should be selected.

### B.6 Probability $P_U$ that a flash to a line will cause injury to living beings by electric shock

The values of probability  $P_U$  of injury to living beings inside the structure due to touch voltage by a flash to a line entering the structure depends on the characteristics of the line shield, the impulse withstand voltage of internal systems connected to the line, the protection measures like physical restrictions or warning notices and the isolating interfaces or SPD(s) provided for equipotential bonding at the entrance of the line according to IEC 62305-3.

NOTE 1 A coordinated SPD system according to IEC 62305-4 is not necessary to reduce  $P_U$ ; in this case SPD(s) according to IEC 62305-3 are sufficient.

The value of  $P_U$  is given by:

$$P_U = P_{TU} \times P_{EB} \times P_{LD} \times C_{LD} \tag{B.8}$$

where

$P_{TU}$  depends on protection measures against touch voltages, such as physical restrictions or warning notices. Values of  $P_{TU}$  are given in Table B.6;

$P_{EB}$  depends on lightning equipotential bonding (EB) conforming to IEC 62305-3 and on the lightning protection level (LPL) for which its SPDs are designed. Values of  $P_{EB}$  are given in Table B.7;

$P_{LD}$  is the probability of failure of internal systems due to a flash to the connected line depending on the line characteristics. Values of  $P_{LD}$  are given in Table B.8.

$C_{LD}$  is a factor depending on shielding, grounding and isolation conditions of the line. Values of  $C_{LD}$  are given in Table B.4.

NOTE 2 When SPD(s) according to IEC 62305-3 are provided for equipotential bonding at the entrance of the line, earthing and bonding according to IEC 62305-4 may improve protection.

**Table B.6 – Values of probability  $P_{TU}$  that a flash to an entering line will cause shock to living beings due to dangerous touch voltages**

Protection measure	$P_{TU}$
No protection measures	1
Warning notices	$10^{-1}$
Electrical insulation	$10^{-2}$
Physical restrictions	0

NOTE 3 If more than one provision has been taken, the value of  $P_{TU}$  is the product of the corresponding values.

**Table B.7 – Value of the probability  $P_{EB}$  as a function of LPL for which SPDs are designed**

LPL	$P_{EB}$
No SPD	1
III-IV	0,05
II	0,02
I	0,01
NOTE 3	0,005 – 0,001

NOTE 4 The values of  $P_{EB}$  may be reduced for SPDs having better protection characteristics (higher nominal current  $I_N$ , lower protective level  $U_P$ , etc.) compared with the requirements defined for LPL I at the relevant installation locations (see Table A.3 of IEC 62305-1:2010 for information on lightning current probabilities, and Annex E of IEC 62305-1:2010 and Annex D of IEC 62305-4:2010 for lightning current sharing). The same annexes may be used for SPDs having higher probabilities  $P_{EB}$ .

**Table B.8 – Values of the probability  $P_{LD}$  depending on the resistance  $R_S$  of the cable screen and the impulse withstand voltage  $U_W$  of the equipment**

Line type	Routing, shielding and bonding conditions		Withstand voltage $U_W$ in kV				
			1	1,5	2,5	4	6
Power lines or Telecom lines	Aerial or buried line, unshielded or shielded whose shield is not bonded to the same bonding bar as equipment		1	1	1	1	1
	Shielded aerial or buried whose shield bonded to the same bonding bar as equipment	$5\Omega/\text{km} < R_S \leq 20 \Omega/\text{km}$	1	1	0,95	0,9	0,8
		$1\Omega/\text{km} < R_S \leq 5 \Omega/\text{km}$	0,9	0,8	0,6	0,3	0,1
		$R_S \leq 1 \Omega/\text{km}$	0,6	0,4	0,2	0,04	0,02

NOTE 5 In suburban/urban areas, an LV power line uses typically unshielded buried cable whereas a telecommunication line uses a buried shielded cable (with a minimum of 20 conductors, a shield resistance of  $5 \Omega/\text{km}$ , a copper wire diameter of 0,6 mm). In rural areas an LV power line uses an unshielded aerial cable whereas a telecommunication line uses an aerial unshielded cable (copper wire diameter: 1 mm). An HV buried power line uses typically a shielded cable with a shield resistance in the order of  $1\Omega/\text{km}$  to  $5 \Omega/\text{km}$ . National committees may improve this information in order to better meet national conditions of power and telecommunication lines.

### B.7 Probability $P_V$ that a flash to a line will cause physical damage

The values of probability  $P_V$  of physical damage by a flash to a line entering the structure depend on the characteristics of the line shield, the impulse withstand voltage of internal systems connected to the line and the isolating interfaces or the SPDs provided for equipotential bonding at the entrance of the line according to IEC 62305-3.

NOTE A coordinated SPD system according to IEC 62305-4 is not necessary to reduce  $P_V$ ; in this case, SPDs according to IEC 62305-3 are sufficient.

The value of  $P_V$  is given by:

$$P_V = P_{EB} \times P_{LD} \times C_{LD} \quad (\text{B.9})$$

where

$P_{EB}$  depends on lightning equipotential bonding (EB) conforming to IEC 62305-3 and on the lightning protection level (LPL) for which its SPDs are designed. Values of  $P_{EB}$  are given in Table B.7;

$P_{LD}$  is the probability of failure of internal systems due to a flash to the connected line depending on the line characteristics. Values of  $P_{LD}$  are given in Table B.8;

$C_{LD}$  is a factor depending on shielding, grounding and isolation conditions of the line. Values of  $C_{LD}$  are given in Table B.4.

### B.8 Probability $P_W$ that a flash to a line will cause failure of internal systems

The values of probability  $P_W$  that a flash to a line entering the structure will cause a failure of internal systems depend on the characteristics of line shielding, the impulse withstand voltage of internal systems connected to the line and the isolating interfaces or the coordinated SPD system installed.

The value of  $P_W$  is given by:

$$P_W = P_{SPD} \times P_{LD} \times C_{LD} \quad (\text{B.10})$$

where

$P_{SPD}$  depends on the coordinated SPD system conforming to IEC 62305-4 and the lightning protection level (LPL) for which its SPDs are designed. Values of  $P_{SPD}$  are given in Table B.3;

$P_{LD}$  is the probability of failure of internal systems due to a flash to the connected line depending on the line characteristics. Values of  $P_{LD}$  are given in Table B.8;

$C_{LD}$  is a factor depending on shielding, grounding and isolation conditions of the line. Values of  $C_{LD}$  are given in Table B.4.

### B.9 Probability $P_Z$ that a lightning flash near an incoming line will cause failure of internal systems

The values of probability  $P_Z$  that a lightning flash near a line entering the structure will cause a failure of internal systems depend on the characteristics of the line shield, the impulse withstand voltage of the system connected to the line and the isolating interfaces or the coordinated SPD system provided.

The value of  $P_Z$  is given by:

$$P_Z = P_{SPD} \times P_{LI} \times C_{LI} \quad (\text{B.11})$$



where

$P_{SPD}$  depends on the coordinated SPD system conforming to IEC 62305-4 and the lightning protection level (LPL) for which its SPDs are designed. Values of  $P_{SPD}$  are given in Table B.3;

$P_{LI}$  is the probability of failure of internal systems due to a flash near the connected line depending on the line and equipment characteristics. Values of  $P_{LI}$  are given in Table B.9;

$C_{LI}$  is a factor depending on shielding, grounding and isolation conditions of the line. Values of  $C_{LI}$  are given in Table B.4.

**Table B.9 – Values of the probability  $P_{LI}$  depending on the line type and the impulse withstand voltage  $U_W$  of the equipment**

Line type	Withstand voltage $U_W$ in kV				
	1	1,5	2,5	4	6
Power lines	1	0,6	0,3	0,16	0,1
TLC lines	1	0,5	0,2	0,08	0,04

NOTE More precise evaluation of  $P_{LI}$  can be found in IEC/TR 62066:2002 for power lines<sup>[11]</sup> and in ITU-T Recommendation K.46<sup>[10]</sup> for telecommunication (TLC) lines.

## Annex C (informative)

### Assessment of amount of loss $L_X$

#### C.1 General

The values of amount of loss  $L_X$  should be evaluated and fixed by the lightning protection designer (or the owner of the structure). The typical mean values of loss  $L_X$  in a structure given in this annex are merely values proposed by the IEC. Different values may be assigned by each national committee or after detailed investigation.

NOTE 1 When the damage to a structure due to lightning may also involve surrounding structures or the environment (e.g. chemical or radioactive emissions), a more detailed evaluation of  $L_X$  that takes into account this additional loss should be performed.

NOTE 2 It is recommended that the equations given in this annex be used as the primary source of values for  $L_X$ .

#### C.2 Mean relative amount of loss per dangerous event

The loss  $L_X$  refers to the mean relative amount of a particular type of damage for one dangerous event caused by a lightning flash, considering both its extent and effects.

The loss value  $L_X$  varies with the type of loss considered:

- L1 (Loss of human life, including permanent injury): the endangered number of persons (victims);
- L2 (Loss of public service): the number of users not served;
- L3 (Loss of cultural heritage): the endangered economic value of structure and content;
- L4 (Loss of economic values): the endangered economic value of animals, the structure (including its activities), content and internal systems,

and, for each type of loss, with the type of damage (D1, D2 and D3) causing the loss.

The loss  $L_X$  should be determined for each zone of the structure into which it is divided.

#### C.3 Loss of human life (L1)

The loss value  $L_X$  for each zone can be determined according to Table C.1, considering that:

- loss of human life is affected by the characteristics of the zone. These are taken into account by increasing ( $h_z$ ) and decreasing ( $r_t$ ,  $r_p$ ,  $r_f$ ) factors;
- the maximum value of loss in the zone shall be reduced by the ratio between the number of persons in the zone ( $n_z$ ) versus the total number of persons ( $n_t$ ) in the whole structure;
- the time in hours per year for which the persons are present in the zone ( $t_z$ ), if it is lower than the total 8 760 h of a year, will also reduce the loss.

**Table C.1 – Type of loss L1: Loss values for each zone**

Type of damage	Typical loss	Equation
D1	$L_A = r_t \times L_T \times n_Z / n_t \times t_z / 8\,760$	(C.1)
D1	$L_U = r_t \times L_T \times n_Z / n_t \times t_z / 8\,760$	(C.2)
D2	$L_B = L_V = r_p \times r_f \times h_z \times L_F \times n_Z / n_t \times t_z / 8\,760$	(C.3)
D3	$L_C = L_M = L_W = L_Z = L_O \times n_Z / n_t \times t_z / 8\,760$	(C.4)

where

$L_T$  is the typical mean relative numbers of victims injured by electric shock (D1) due to one dangerous event (see Table C.2);

$L_F$  is the typical mean relative numbers of victims by physical damage (D2) due to one dangerous event (see Table C.2);

$L_O$  is the typical mean relative numbers of victims by failure of internal systems (D3) due to one dangerous event (see Table C.2);

$r_t$  is a factor reducing the loss of human life depending on the type of soil or floor (see Table C.3);

$r_p$  is a factor reducing the loss due to physical damage depending on the provisions taken to reduce the consequences of fire (see Table C.4);

$r_f$  is a factor reducing the loss due to physical damage depending on the risk of fire or on the risk of explosion of the structure (see Table C.5);

$h_z$  is a factor increasing the loss due to physical damage when a special hazard is present (see Table C.6);

$n_Z$  is the number of persons in the zone;

$n_t$  is the total number of persons in the structure;

$t_z$  is the time in hours per year for which the persons are present in the zone.

**Table C.2 – Type of loss L1: Typical mean values of  $L_T$ ,  $L_F$  and  $L_O$** 

Type of damage	Typical loss value	Type of structure
D1 injuries	$L_T$	$10^{-2}$ All types
D2 physical damage	$L_F$	$10^{-1}$ Risk of explosion
		$10^{-1}$ Hospital, hotel, school, civic building
		$5 \times 10^{-2}$ Public entertainment, church, museum
		$2 \times 10^{-2}$ Industrial, commercial
		$10^{-2}$ Others
D3 failure of internal systems	$L_O$	$10^{-1}$ Risk of explosion
		$10^{-2}$ Intensive care unit and operation block of hospital
		$10^{-3}$ Other parts of hospital

NOTE 1 Values of Table C.2 refer to a continuous attendance of people in the structure.

NOTE 2 In case of a structure with risk of explosion, the values for  $L_F$  and  $L_O$  may need a more detailed evaluation, considering the type of structure, the risk explosion, the zone concept of hazardous areas and the measures to meet the risk.

When the damage to a structure due to lightning involves surrounding structures or the environment (e.g. chemical or radioactive emissions), additional loss ( $L_E$ ) should be taken into account to evaluate the total loss ( $L_{FT}$ ):

$$L_{FT} = L_F + L_E \tag{C.5}$$

where

$$L_E = L_{FE} \times t_e / 8\ 760 \tag{C.6}$$

$L_{FE}$  being the loss due to physical damage outside the structure;

$t_e$  being the time of presence of people in the dangerous place outside the structure.

NOTE 3 If values of  $L_{FE}$  and  $t_e$  are unknown,  $L_{FE} \times t_e / 8\ 760 = 1$  should be assumed.

**Table C.3 – Reduction factor  $r_t$  as a function of the type of surface of soil or floor**

Type of surface <sup>b</sup>	Contact resistance k Ω <sup>a</sup>	$r_t$
Agricultural, concrete	≤ 1	10 <sup>-2</sup>
Marble, ceramic	1 – 10	10 <sup>-3</sup>
Gravel, moquette, carpets	10 – 100	10 <sup>-4</sup>
Asphalt, linoleum, wood	≥ 100	10 <sup>-5</sup>

<sup>a</sup> Values measured between a 400 cm<sup>2</sup> electrode compressed with a uniform force of 500 N and a point of infinity.

<sup>b</sup> A layer of insulating material, e.g. asphalt, of 5 cm thickness (or a layer of gravel 15 cm thick) generally reduces the hazard to a tolerable level.

**Table C.4 – Reduction factor  $r_p$  as a function of provisions taken to reduce the consequences of fire**

Provisions	$r_p$
No provisions	1
One of the following provisions: extinguishers; fixed manually operated extinguishing installations; manual alarm installations; hydrants; fire compartments; escape routes	0,5
One of the following provisions: fixed automatically operated extinguishing installations; automatic alarm installations <sup>a</sup>	0,2

<sup>a</sup> Only if protected against overvoltages and other damages and if firemen can arrive in less than 10 min.

If more than one provision has been taken, the value of  $r_p$  should be taken as the lowest of the relevant values.

In structures with risk of explosion,  $r_p = 1$  for all cases.

**Table C.5 – Reduction factor  $r_f$  as a function of risk of fire or explosion of structure**

Risk	Amount of risk	$r_f$
Explosion	Zones 0, 20 and solid explosive	1
	Zones 1, 21	$10^{-1}$
	Zones 2, 22	$10^{-3}$
Fire	High	$10^{-1}$
	Ordinary	$10^{-2}$
	Low	$10^{-3}$
Explosion or fire	None	0

NOTE 4 In case of a structure with risk of explosion, the value for  $r_f$  may need a more detailed evaluation.

NOTE 5 Structures with a high risk of fire may be assumed to be structures made of combustible materials or structures with roofs made of combustible materials or structures with a specific fire load larger than 800 MJ/m<sup>2</sup>.

NOTE 6 Structures with an ordinary risk of fire may be assumed to be structures with a specific fire load between 800 MJ/m<sup>2</sup> and 400 MJ/m<sup>2</sup>.

NOTE 7 Structures with a low risk of fire may be assumed to be structures with a specific fire load less than 400 MJ/m<sup>2</sup>, or structures containing only a small amount of combustible material.

NOTE 8 Specific fire load is the ratio of the energy of the total amount of the combustible material in a structure and the overall surface of the structure.

NOTE 9 For the purposes of this part of IEC 62305, structures containing hazardous zones or containing solid explosive materials should not be assumed to be structures with a risk of explosion if any one of the following conditions is fulfilled:

- the time of presence of explosive substances is lower than 0,1 h/year;
- the volume of explosive atmosphere is negligible according to IEC 60079-10-1<sup>[2]</sup> and IEC 60079-10-2<sup>[3]</sup>;
- the zone cannot be hit directly by a flash and dangerous sparking in the zone is avoided.

NOTE 10 For hazardous zones enclosed within metallic shelters, condition c) is fulfilled when the shelter, as a natural air-termination system, acts safely without puncture or hot-spot problems, and internal systems inside the shelter, if any, are protected against overvoltages to avoid dangerous sparking.

**Table C.6 – Factor  $h_z$  increasing the relative amount of loss in presence of a special hazard**

Kind of special hazard	$h_z$
No special hazard	1
Low level of panic (e.g. a structure limited to two floors and the number of persons not greater than 100)	2
Average level of panic (e.g. structures designed for cultural or sport events with a number of participants between 100 and 1 000 persons)	5
Difficulty of evacuation (e.g. structures with immobile persons, hospitals)	5
High level of panic (e.g. structures designed for cultural or sport events with a number of participants – greater than 1 000 persons)	10

#### C.4 Unacceptable loss of service to the public (L2)

The loss value  $L_X$  for each zone can be determined according to Table C.7, considering that:

- loss of public service is affected by the characteristics of the zone of the structure. These are taken into account by decreasing ( $r_f$ ,  $r_p$ ) factors;

- the maximum value of loss due to the damage in the zone must be reduced by the ratio between the number of users served by the zone ( $n_z$ ) versus the total number of users ( $n_t$ ) served by the whole structure.

**Table C.7 – Type of loss L2: Loss values for each zone**

Type of damage	Typical loss	Equation
D2	$L_B = L_V = r_p \times r_f \times L_F \times n_z/n_t$	(C.7)
D3	$L_C = L_M = L_W = L_Z = L_O \times n_z/n_t$	(C.8)

where

- $L_F$  is the typical mean relative number of users not served, resulting from physical damage (D2) due to one dangerous event (see Table C.8);
- $L_O$  is the typical mean relative numbers of users not served resulting from failure of internal systems (D3) due to one dangerous event (see Table C.8);
- $r_p$  is a factor reducing the loss due to physical damage depending on the provisions taken to reduce the consequences of fire (see Table C.4);
- $r_f$  is a factor reducing the loss due to physical damage depending on the risk of fire (see Table C.5);
- $n_z$  is the number of users served by the zone;
- $n_t$  is the total number of users served by the structure.

**Table C.8 – Type of loss L2: Typical mean values of  $L_F$  and  $L_O$**

Type of damage	Typical loss value	Type of service
D2 physical damage	$L_F$	$10^{-1}$ Gas, water, power supply
		$10^{-2}$ TV, telecommunications lines
D3 failure of internal systems	$L_O$	$10^{-2}$ Gas, water, power supply
		$10^{-3}$ TV, telecommunications lines

### C.5 Loss of irreplaceable cultural heritage (L3)

The loss value  $L_X$  for each zone can be determined according to Table C.9, considering that:

- loss of cultural heritage is affected by the characteristics of the zone. These are taken into account by decreasing ( $r_f, r_p$ ) factors;
- the maximum value of loss due to the damage of the zone must be reduced by the ratio between the value of the zone ( $c_z$ ) versus the total value ( $c_t$ ) of the whole structure (building and content).

**Table C.9 – Type of loss L3: Loss values for each zone**

Type of damage	Typical loss value	Equation
D2 physical damage	$L_B = L_V = r_p \times r_f \times L_F \times c_z / c_t$	(C.9)

where

- $L_F$  is the typical mean relative value of all goods damaged by physical damage (D2) due to one dangerous event (see Table C.10);
- $r_p$  is a factor reducing the loss due to physical damage depending on the provisions taken to reduce the consequences of fire (see Table C.4);
- $r_f$  is a factor reducing the loss due to physical damage depending on the risk of fire (see Table C.5);

$c_z$  is the value of cultural heritage in the zone;

$c_t$  is the total value of building and content of the structure (sum over all zones).

**Table C.10 – Type of loss L3: Typical mean value of  $L_F$**

Type of damage	Typical loss value		Type of structure or zone
D2 physical damage	$L_F$	$10^{-1}$	Museums, galleries

## C.6 Economic loss (L4)

The loss value  $L_X$  for each zone can be determined according to Table C.11, considering that:

- loss of economic values is affected by the characteristics of the zone. These are taken into account by decreasing ( $r_t$ ,  $r_p$ ,  $r_f$ ) factors;
- the maximum value of loss due to the damage of the zone must be reduced by the ratio between the relevant value in the zone versus the total value ( $c_t$ ) of the whole structure (animals, building, content and internal systems including their activities). The relevant value of the zone depends on the type of damage:

D1 (injuries of animals due to shock):  $c_a$  (value of animals only)

D2 (physical damage):  $c_a + c_b + c_c + c_s$  (value of all goods)

D3 (failures of internal systems):  $c_s$  (value of internal systems and their activities only)

**Table C.11 – Type of loss L4: Loss values for each zone**

Type of damage	Typical loss	Equation
D1	$L_A = r_t \times L_T \times c_a / c_t^a$	(C.10)
D1	$L_U = r_t \times L_T \times c_a / c_t^a$	(C.11)
D2	$L_B = L_V = r_p \times r_f \times L_F \times (c_a + c_b + c_c + c_s) / c_t^a$	(C.12)
D3	$L_C = L_M = L_W = L_Z = L_O \times c_s / c_t^a$	(C.13)

<sup>a</sup> The ratios  $c_a / c_t$  and  $(c_a + c_b + c_c + c_s) / c_t$  and  $c_s / c_t$  have only to be considered in the eq. (C.10) – (C.13), if the risk assessment is conducted in accordance with clause 6.10, using Annex D. In case of using a representative value for the tolerable risk R4 in accordance with Table 4, the ratios do not have to be taken into account. In these cases, the ratios have to be replaced by the value 1.

where

$L_T$  is the typical mean relative value of all goods damaged by electric shock (D1) due to one dangerous event (see Table C.12);

$L_F$  is the typical mean relative value of all goods damaged by physical damage (D2) due to one dangerous event (see Table C.12);

$L_O$  is the typical mean relative value of all goods damaged by failure of internal systems (D3) due to one dangerous event (see Table C.12);

$r_t$  is a factor reducing the loss of animals depending on the type of soil or floor (see Table C.3);

$r_p$  is a factor reducing the loss due to physical damage depending on the provisions taken to reduce the consequences of fire (see Table C.4);

$r_f$  is a factor reducing the loss due to physical damage depending on the risk of fire or on the risk of explosion of the structure (see Table C.5);

- $c_a$  is the value of animals in the zone;
- $c_b$  is the value of building relevant to the zone;
- $c_c$  is the value of content in the zone;
- $c_s$  is the value of internal systems including their activities in the zone;
- $c_t$  is the total value of the structure (sum over all zones for animals, building, content and internal systems including their activities).

**Table C.12 – Type of loss L4: Typical mean values of  $L_T$ ,  $L_F$  and  $L_O$**

Type of damage	Typical loss value		Type of structure
D1 injuries due to shock	$L_T$	$10^{-2}$	All types where only animals are present
D2 physical damage	$L_F$	1	Risk of explosion
		0,5	Hospital, industrial, museum, agricultural
		0,2	Hotel, school, office, church, public entertainment, commercial
		$10^{-1}$	Others
D3 failure of internal systems	$L_O$	$10^{-1}$	Risk of explosion
		$10^{-2}$	Hospital, industrial, office, hotel, commercial
		$10^{-3}$	Museum, agricultural, school, church, public entertainment
		$10^{-4}$	Others

NOTE 1 In structures where there is a risk of explosion, the values for  $L_F$  and  $L_O$  may need more detailed evaluation, where consideration of the type of structure, the risk explosion, the zone concept of hazardous areas and the measures to meet the risk, etc. are addressed.

When the damage to a structure due to lightning involves surrounding structures or the environment (e.g. chemical or radioactive emissions), additional loss ( $L_E$ ) should be taken into account to evaluate the total loss ( $L_{FT}$ ):

$$L_{FT} = L_F + L_E \tag{C.14}$$

where

$$L_E = L_{FE} \times c_e / c_t \tag{C.15}$$

$L_{FE}$  is the loss due to physical damage outside the structure;

$c_e$  is the total value of goods in dangerous place outside the structure.

NOTE 2 If the value of  $L_{FE}$  is unknown,  $L_{FE} = 1$  should be assumed.



## Annex D (informative)

### Evaluation of costs of loss

The cost of loss  $C_{LZ}$  in a zone may be calculated by the following equation:

$$C_{LZ} = R_{4Z} \times c_t \quad (D.1)$$

where

$R_{4Z}$  is the risk related to loss of value in the zone, without protection measures;

$c_t$  is the total value of the structure (animals, building, content and internal systems including their activities in currency).

The cost of total loss  $C_L$  in the structure may be calculated by the following equation:

$$C_L = \sum C_{LZ} = R_4 \times c_t \quad (D.2)$$

where

$R_4 = \sum R_{4Z}$  is the risk related to loss of value, without protection measures.

The cost  $C_{RLZ}$  of residual loss in a zone in spite of protection measures may be calculated by means of the equation:

$$C_{RLZ} = R'_{4Z} \times c_t \quad (D.3)$$

where

$R'_{4Z}$  is the risk related to loss of value in the zone, with protection measures.

The total cost  $C_{RL}$  of residual loss in the structure in spite of protection measures may be calculated by means of the equation:

$$C_{RL} = \sum C_{RLZ} = R'_4 \times c_t \quad (D.4)$$

where

$R'_4 = \sum R'_{4Z}$  is the risk related to loss of value in the structure, with protection measures.

The annual cost  $C_{PM}$  of protection measures may be calculated by means of the equation:

$$C_{PM} = C_P \times (i + a + m) \quad (D.5)$$

where

$C_P$  is the cost of protection measures;

$i$  is the interest rate;

$a$  is the amortization rate;

$m$  is the maintenance rate.

The annual saving  $S_M$  in money is:

$$S_M = C_L - (C_{PM} + C_{RL}) \quad (D.6)$$

Protection is justified if the annual saving  $S_M > 0$ .

## Annex E (informative)

### Case study

#### E.1 General

In Annex E case studies relevant to a country house, an office building, a hospital and an apartment block are developed with the aim of showing

- how to calculate the risk and determine the need for protection,
- the contribution of different risk components to the overall risk,
- the effect of different protection measures to mitigate the risk,
- the method of selection from among different protection solutions taking into account the cost-effectiveness.

NOTE This annex presents hypothetical data for all cases. It is intended to provide information about risk evaluation in order to illustrate the principles contained in this part of IEC 62305. It is not intended to address the unique aspects of the conditions that exist in all facilities or systems.

#### E.2 Country house

As a first case study a country house (Figure E.1) is considered.

Loss of human life (L1) and economic loss (L4) are relevant for this type of structure.

It is required to evaluate the need for protection. This implies the need to determine only the risk  $R_1$  for loss of human life (L1) with the risk components  $R_A$ ,  $R_B$ ,  $R_U$  and  $R_V$  (according to Table 2) and to compare it with the tolerable risk  $R_T = 10^{-5}$  (according to Table 4). Suitable protection measures to mitigate such risk will be selected.

Following the decision taken by the owner that an economic evaluation is not required, the risk  $R_4$  for economic loss (L4) is not considered.

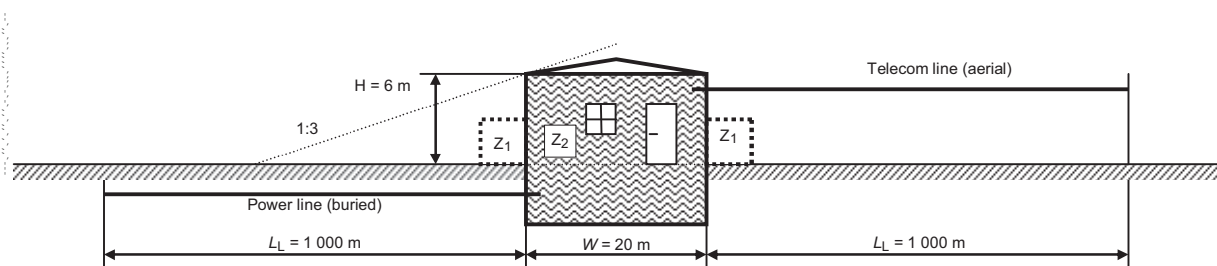

IEC 2642/10

#### Key

$Z_1$ : outside

$Z_2$ : rooms block

**Figure E.1 – Country house**

#### E.2.1 Relevant data and characteristics

The country house is located in flat territory without any neighbouring structures. The lightning flash density is  $N_G = 4$  flashes per  $\text{km}^2$  per year. Five persons live in the house. This is also the total number of persons to be considered, because it is assumed that there is no person outside the house during thunderstorm.

Data for the house and its surroundings are given in Table E.1.

Data for the incoming lines and their internal systems connected to are given for the power line in Table E.2 and for the telecom line in Table E.3.

**Table E.1 – Country house: Environment and structure characteristics**

Input parameter	Comment	Symbol	Value	Reference
Ground flash density (1/km <sup>2</sup> /year)		$N_G$	4,0	
Structure dimensions (m)		$L, W, H$	15, 20, 6	
Location factor of structure	Isolated structure	$C_D$	1	Table A.1
LPS	None	$P_B$	1	Table B.2
Equipotential bonding	None	$P_{EB}$	1	Table B.7
External spatial shield	None	$K_{S1}$	1	Equation (B.5)

**Table E.2 – Country house: Power line**

Input parameter	Comment	Symbol	Value	Reference
Length (m) <sup>a</sup>		$L_L$	1 000	
Installation factor	Buried	$C_I$	0,5	Table A.2
Line type factor	LV line	$C_T$	1	Table A.3
Environmental factor	Rural	$C_E$	1	Table A.4
Shield of line	Unshielded	$R_S$	–	Table B.8
Shielding, grounding, isolation	None	$C_{LD}$	1	Table B.4
		$C_{LI}$	1	
Adjacent structure	None	$L_J, W_J, H_J$	–	
Location factor of structure	None	$C_{DJ}$	–	Table A.1
Withstand voltage of internal system (kV)		$U_W$	2,5	
	Resulting parameters	$K_{S4}$	0,4	Equation (B.7)
		$P_{LD}$	1	Table B.8
		$P_{LI}$	0,3	Table B.9

<sup>a</sup> As the length  $L_L$  of the line section is unknown,  $L_L = 1\,000$  m is assumed (Clause A.4 and Clause A.5).

**Table E.3 – Country house: Telecom line (TLC)**

Input parameter	Comment	Symbol	Value	Reference
Length (m) <sup>a</sup>		$L_L$	1 000 m	
Installation factor	Aerial	$C_I$	1	Table A.2
Line type factor	Telecom line	$C_T$	1	Table A.3
Environmental factor	Rural	$C_E$	1	Table A.4
Shield of line	Unshielded	$R_S$	–	Table B.8
Shielding, grounding, isolation	None	$C_{LD}$	1	Table B.4
		$C_{LI}$	1	
Adjacent structure	None	$L_J, W_J, H_J$	–	
Location factor of structure	Isolated structure	$C_{DJ}$	–	Table A.1
Withstand voltage of internal		$U_W$	1,5	

Input parameter	Comment	Symbol	Value	Reference
system (kV)				
	Resulting parameters	$K_{S4}$	0,67	Equation (B.7)
		$P_{LD}$	1	Table B.8
		$P_{LI}$	0,5	Table B.9
<sup>a</sup> As the length $L_L$ of the line section is unknown, $L_L = 1\ 000$ m is assumed (Clause A.4 and Clause A.5).				

### E.2.2 Definition of zones in the country house

The following main zones may be defined:

- $Z_1$  (outside the building);
- $Z_2$  (inside the building).

For zone  $Z_1$  it is assumed, that no people are outside the building. Therefore the risk of shock of people  $R_A = 0$ . Because  $R_A$  is the only risk component outside the building, zone  $Z_1$  can be disregarded completely.

Inside the building only one zone  $Z_2$  is defined taking into account that

- both internal systems (power and telecom) extend throughout the building,
- no spatial shields exist,
- the structure is a unique fireproof compartment,
- losses are assumed to be constant in all the building and to correspond to the typical mean values of Table C.1.

The resulting factors valid for zone  $Z_2$  are reported in Table E.4.

**Table E.4 – Country house: Factors valid for zone  $Z_2$  (inside the building)**

Input parameter	Comment	Symbol	Value	Reference
Type of floor	Linoleum	$r_t$	$10^{-5}$	Table C.3
Protection against shock (flash to structure)	None	$P_{TA}$	1	Table B.1
Protection against shock (flash to line)	None	$P_{TU}$	1	Table B.6
Risk of fire	Low	$r_f$	$10^{-3}$	Table C.5
Fire protection	None	$r_p$	1	Table C.4
Internal spatial shield	None	$K_{S2}$	1	Equation (B.6)
Power	Internal wiring (loop conductors in the same conduit)	$K_{S3}$	0,2	Table B.5
	Coordinated SPDs	None	$P_{SPD}$	1
Telecom	Internal wiring (large loops >10 m <sup>2</sup> )	$K_{S3}$	1	Table B.5
	Coordinated SPDs	None	$P_{SPD}$	1
L1: Loss of human life	Special hazard: none	$h_z$	1	Table C.6
	D1: due to touch and step voltage	$L_T$	$10^{-2}$	Table C.2
	D2: due to physical damage	$L_F$	$10^{-1}$	
	D3: due to failure of internal systems	$L_O$	-	

Input parameter	Comment	Symbol	Value	Reference
Factor for persons in zone	$n_z/n_t \times t_z/8\ 760 = 5/5 \times 8\ 760/8\ 760$	–	1	
	Resulting parameters	$L_A$	$10^{-7}$	Equation (C.1)
		$L_U$	$10^{-7}$	Equation (C.2)
		$L_B$	$10^{-4}$	Equation (C.3)
		$L_V$	$10^{-4}$	Equation (C.3)

### E.2.3 Calculation of relevant quantities

Calculations are given in Table E.5 for the collection areas and in Table E.6 for the expected number of dangerous events.

**Table E.5 – Country house: Collection areas of structure and lines**

	Symbol	Result m <sup>2</sup>	Reference Equation	Equation
Structure	$A_D$	$2,58 \times 10^3$	(A.2)	$A_D = L \times W + 2 \times (3 \times H) \times (L + W) + \pi \times (3 \times H)^2$
	$A_M$	–	(A.7)	Not relevant
Power line	$A_{L/P}$	$4,00 \times 10^4$	(A.9)	$A_{L/P} = 40 \times L_L$
	$A_{I/P}$	$4,00 \times 10^6$	(A.11)	$A_{L/P} = 4\ 000 \times L_L$
	$A_{DJ/P}$	0	(A.2)	No adjacent structure
Telecom line	$A_{L/T}$	$4,00 \times 10^4$	(A.9)	$A_{L/T} = 40 \times L_L$
	$A_{I/T}$	$4,00 \times 10^6$	(A.11)	$A_{L/T} = 4\ 000 \times L_L$
	$A_{DJ/T}$	0	(A.2)	No adjacent structure

**Table E.6 – Country house: Expected annual number of dangerous events**

	Symbol	Result 1/year	Reference Equation	Equation
Structure	$N_D$	$1,03 \times 10^{-2}$	(A.4)	$N_D = N_G \times A_D \times C_D \times 10^{-6}$
	$N_M$	–	(A.6)	Not relevant
Power Line	$N_{L/P}$	$8,00 \times 10^{-2}$	(A.8)	$N_{L/P} = N_G \times A_{L/P} \times C_{I/P} \times C_{E/P} \times C_{T/P} \times 10^{-6}$
	$N_{I/P}$	8,00	(A.10)	$N_{I/P} = N_G \times A_{I/P} \times C_{I/P} \times C_{E/P} \times C_{T/P} \times 10^{-6}$
	$N_{DJ/P}$	0	(A.5)	No adjacent structure
Telecom Line	$N_{L/T}$	$1,60 \times 10^{-1}$	(A.8)	$N_{L/T} = N_G \times A_{L/T} \times C_{I/T} \times C_{E/T} \times C_{T/T} \times 10^{-6}$
	$N_{I/T}$	16	(A.10)	$N_{I/T} = N_G \times A_{I/T} \times C_{I/T} \times C_{E/T} \times C_{T/T} \times 10^{-6}$
	$N_{DJ/T}$	0	(A.5)	No adjacent structure

### E.2.4 Risk $R_1$ – Determination of need of protection

The risk  $R_1$  can be expressed according to Equation (1) by the following sum of components:

$$R_1 = R_A + R_B + R_{U/P} + R_{V/P} + R_{U/T} + R_{V/T}$$

Risk components are to be evaluated according to Table 6.

Involved components and total risk evaluation are given in Table E.7

**Table E.7 – Country house: Risk  $R_1$  for the unprotected structure (values  $\times 10^{-5}$ )**

	Symbol	$Z_1$	$Z_2$	Structure
D1 Injury	$R_A$	–	$\approx 0$	$\approx 0$
	$R_U = R_{U/P} + R_{U/T}$		0,002	<b>0,002</b>
D2 Physical damage	$R_B$		0,103	<b>0,103</b>
	$R_V = R_{V/P} + R_{V/T}$		2,40	<b>2,40</b>
<b>Total</b>		–	<b>2,51</b>	$R_1 = 2,51$
<b>Tolerable</b>		$R_1 > R_T$ : Lightning protection is required		$R_T = 1$

Because  $R_1 = 2,51 \times 10^{-5}$  is higher than the tolerable value  $R_T = 10^{-5}$ , lightning protection for the structure is required.

### E.2.5 Risk $R_1$ – Selection of protection measures

According to Table E.7 the main contributions to the value of risk are given by:

- component  $R_V$  (lightning flash to lines) of 96 %;
- component  $R_B$  (lightning flash to structure) of 4 %.

To reduce the risk  $R_1$  to a tolerable value, the protective measures influencing the components  $R_V$  and  $R_B$  should be considered. Suitable measures include:

- a) installing SPDs of LPL IV at the line entrance (lightning equipotential bonding) to protect both power and telephone lines in the house. According to Table B.7 this reduces the value of  $P_{EB}$  (due to SPDs on connected lines) from 1 to 0,05 and the values of  $P_U$  and  $P_V$  by the same factor;
- b) installing an LPS of class IV (including mandatory lightning equipotential bonding). According to Tables B.2 and B.7 this reduces the value of  $P_B$  from 1 to 0,2 and the value of  $P_{EB}$  (due to SPDs on connected lines) from 1 to 0,05 and finally the values of  $P_U$  and  $P_V$  by the same factor.

Inserting these values into the equations, new values of risk components are obtained, as shown in Table E.8.

**Table E.8 – Country house: Risk components relevant to risk  $R_1$  for protected structure**

Type of damage	Symbol	Result case a) $\times (10^{-5})$	Result case b) $\times (10^{-5})$
D1 Injury due to shock	$R_A$	$\approx 0$	$\approx 0$
	$R_U = R_{U/P} + R_{U/T}$	$\approx 0$	$\approx 0$
D2 Physical damage	$R_B$	0,103	0,021
	$R_V$	0,120	0,120
<b>Total</b>	$R_1$	<b>0,223</b>	<b>0,141</b>

The choice of solution is decided on economic and technical factors.

## E.3 Office building

As a second case study, an office building with an archive, offices and a computer centre is considered (Figure E.2).

Loss of human life (L1) and economic loss (L4) are relevant for this type of structure.

It is required to evaluate the need for protection. This implies the determination of only the risk  $R_1$  for loss of human life (L1) with the risk components  $R_A$ ,  $R_B$ ,  $R_U$  and  $R_V$  (according to Table 2) and to compare it with the tolerable risk  $R_T = 10^{-5}$  (according to Table 4). Suitable protection measures will be selected to reduce the risk to or below the tolerable risk.

Following the decision taken by the owner an economic evaluation is not requested; therefore the risk  $R_4$  for economic loss (L4) is not considered.

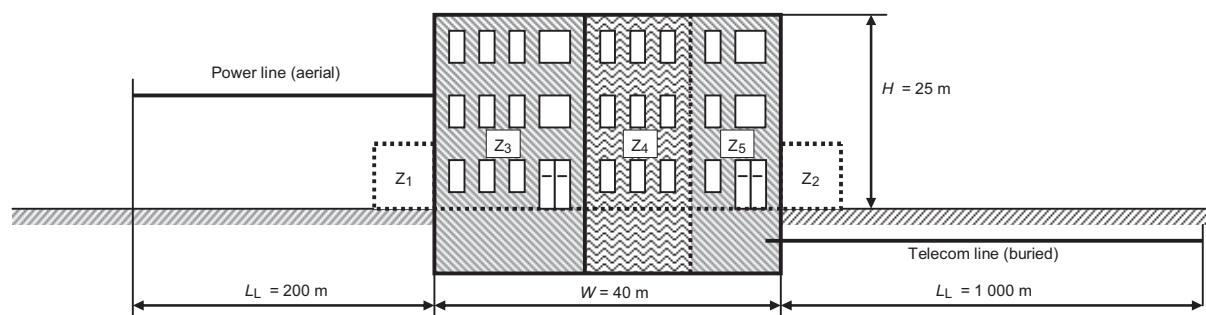

IEC 2643/10

#### Key

Z<sub>1</sub>: entrance (outside)

Z<sub>2</sub>: garden (inside)

Z<sub>3</sub>: archive

Z<sub>4</sub>: offices

Z<sub>5</sub>: computer centre

**Figure E.2 – Office building**

### E.3.1 Relevant data and characteristics

The office building is located in flat territory without any neighbouring structures. The lightning flash density is  $N_G = 4$  flashes per km<sup>2</sup> per year.

Data for the building and its surroundings are given in Table E.9.

Data for the incoming lines and their connected internal systems are given for the power line in Table E.10 and for the telecom line in Table E.11.

**Table E.9 – Office building: Environment and structure characteristics**

Input parameter	Comment	Symbol	Value	Reference
Ground flash density (1/km <sup>2</sup> /year)		$N_G$	4,0	
Structure dimensions (m)		$L, W, H$	20, 40, 25	
Location factor of structure	Isolated structure	$C_D$	1	Table A.1
LPS	None	$P_B$	1	Table B.2
Equipotential bonding	None	$P_{EB}$	1	Table B.7
External spatial shield	None	$K_{S1}$	1	Equation (B.5)

**Table E.10 – Office building: Power line**

Input parameter	Comment	Symbol	Value	Reference
Length (m)		$L_L$	200	
Installation factor	Aerial	$C_I$	1	Table A.2
Line type factor	LV line	$C_T$	1	Table A.3
Environmental factor	Rural	$C_E$	1	Table A.4
Shield of line ( $\Omega/\text{km}$ )	Unshielded	$R_S$	–	Table B.8
Shielding, grounding, isolation	None	$C_{LD}$	1	Table B.4
		$C_{LI}$	1	
Adjacent structure	None	$L_J, W_J, H_J$	–	
Location factor of adjacent structure	None	$C_{DJ}$	–	Table A.1
Withstand voltage of internal system (kV)		$U_W$	2,5	
	Resulting parameters	$K_{S4}$	0,4	Equation (B.7)
		$P_{LD}$	1	Table B.8
		$P_{LI}$	0,3	Table B.9

**Table E.11 – Office building: Telecom line**

Input parameter	Comment	Symbol	Value	Reference
Length (m)		$L_L$	1 000	
Installation factor	Buried	$C_I$	0,5	Table A.2
Line type factor	Telecom line	$C_T$	1	Table A.3
Environmental factor	Rural	$C_E$	1	Table A.4
Shield of line ( $\Omega/\text{km}$ )	Unshielded	$R_S$	–	Table B.8
Shielding, grounding, isolation	None	$C_{LD}$	1	Table B.4
		$C_{LI}$	1	
Adjacent structure	None	$L_J, W_J, H_J$	–	
Location factor of adjacent structure	None	$C_{DJ}$	–	Table A.1
Withstand voltage of internal system (kV)		$U_W$	1,5	
	Resulting parameters	$K_{S4}$	0,67	Equation (B.7)
		$P_{LD}$	1	Table B.8
		$P_{LI}$	0,5	Table B.9

### E.3.2 Definition of zones in the office building

The following zones are defined:

$Z_1$  (entrance area outside);

$Z_2$  (garden outside);

$Z_3$  (archive);

$Z_4$  (offices);

$Z_5$  (computer centre);

taking into account that:

- the type of surface is different in the entrance area outside, the garden outside and inside the structure;



- the structure is divided into two separate fireproof compartments: the first is the archive ( $Z_3$ ) and the second is the offices together with the computer centre ( $Z_4$  and  $Z_5$ );
- in all inner zones,  $Z_3$ ,  $Z_4$  and  $Z_5$ , internal systems connected to power as well as to telecom lines exist;
- no spatial shields exist.

In the different zones inside and outside the office building a total number of 200 persons shall be considered.

The number of persons related to each zone is different. The distribution into the individual zones is shown in Table E.12. These values are used later to subdivide the total loss values into fractions for each zone.

**Table E.12 – Office building: Distribution of persons into zones**

Zone	Number of persons	Time of presence
$Z_1$ (entrance outside)	4	8 760
$Z_2$ (garden outside)	2	8 760
$Z_3$ (archive)	20	8 760
$Z_4$ (offices)	160	8 760
$Z_5$ (computer centre)	14	8 760
<b>Total</b>	$n_t = 200$	–

Following the evaluation by the lightning protection designer, the typical mean values of relative amount of loss per year relevant to risk  $R_1$  (see Table C.1) for the whole structure are

- $L_T = 10^{-2}$  (outside the structure),
- $L_T = 10^{-2}$  (inside the structure),
- $L_F = 0,02$  classified as “commercial building”.

These global values were reduced for each zone according to the number of people endangered in the individual zone related to the total number of people considered.

The resulting characteristics of the zones  $Z_1$  to  $Z_5$  are given in the Tables E.13 to E.17.

**Table E.13 – Office building: Factors valid for zone  $Z_1$  (entrance area outside)**

Input parameter	Comment	Symbol	Value	Reference
Ground surface	Marble	$r_t$	$10^{-3}$	Table C.3
Protection against shock	None	$P_{TA}$	1	Table B.1
Risk of fire	None	$r_f$	0	Table C.5
Fire protection	None	$r_p$	1	Table C.4
Internal spatial shield	None	$K_{S2}$	1	Equation (B.6)
L1: Loss of human life	Special hazard: None	$h_z$	1	Table C.6
	D1: due to touch and step voltage	$L_T$	$10^{-2}$	Table C.2
	D2: due to physical damage	$L_F$	–	
	D3: due to failure of internal systems	$L_O$	–	
Factor for persons in zone	$n_z/n_t \times t_z/8\ 760 = 4/200 \times 8\ 760/8\ 760$	–	0,02	

**Table E.14 – Office building: Factors valid for zone Z<sub>2</sub> (garden outside)**

Input parameter	Comment	Symbol	Value	Reference
Ground surface	Grass	$r_t$	$10^{-2}$	Table C.3
Protection against shock	Fence	$P_{TA}$	0	Table B.1
Risk of fire	None	$r_f$	0	Table C.5
Fire protection	None	$r_p$	1	Table C.4
Internal spatial shield	None	$K_{S2}$	1	Equation (B.6)
L1: Loss of human life	Special hazard: None	$h_z$	1	Table C.6
	D1: due to touch and step voltage	$L_T$	$10^{-2}$	Table C.2
	D2: due to physical damage	$L_F$	–	
	D3: due to failure of internal systems	$L_O$	–	
Factor for persons in zone	$n_z/n_t \times t_z/8\ 760 = 2/200 \times 8\ 760/8\ 760$	–	0,01	

**Table E.15 – Office building: Factors valid for zone Z<sub>3</sub> (archive)**

Input parameter	Comment	Symbol	Value	Reference
Type of floor	Linoleum	$r_t$	$10^{-5}$	Table C.3
Protection against shock (flash to structure)	None	$P_{TA}$	1	Table B.1
Protection against shock (flash to line)	None	$P_{TU}$	1	Table B.6
Risk of fire	High	$r_f$	$10^{-1}$	Table C.5
Fire protection	None	$r_p$	1	Table C.4
Internal spatial shield	None	$K_{S2}$	1	Equation (B.6)
Power	Internal wiring (loop conductors in the same conduit)	$K_{S3}$	0,2	Table B.5
	Coordinated SPDs	None	$P_{SPD}$	1
Telecom	Internal wiring (large loops >10m <sup>2</sup> )	$K_{S3}$	1	Table B.5
	Coordinated SPDs	None	$P_{SPD}$	1
L1: Loss of human life	Special hazard: low panic	$h_z$	2	Table C.6
	D1: due to touch and step voltage	$L_T$	$10^{-2}$	Table C.2
	D2: due to physical damage	$L_F$	0,02	
	D3: due to failure of internal systems	$L_O$	–	
Factor for endangered persons	$n_z/n_t \times t_z/8\ 760 = 20/200 \times 8\ 760/8\ 760$	–	0,10	

**Table E.16 – Office building: Factors valid for zone Z<sub>4</sub> (offices)**

Input parameter	Comment	Symbol	Value	Reference
Type of floor	Linoleum	$r_t$	$10^{-5}$	Table C.3
Protection against shock (flash to structure)	None	$P_{TA}$	1	Table B.1
Protection against shock (flash to line)	None	$P_{TU}$	1	Table B.6
Risk of fire	Low	$r_f$	$10^{-3}$	Table C.5
Fire protection	None	$r_p$	1	Table C.4
Internal spatial shield	None	$K_{S2}$	1	Equation (B.6)
Power	Internal wiring (loop conductors in the same conduit)	$K_{S3}$	0,2	Table B.5

Input parameter		Comment	Symbol	Value	Reference
	Coordinated SPDs	None	$P_{SPD}$	1	Table B.3
Telecom	Internal wiring	Unshielded (large loops > 10 m <sup>2</sup> )	$K_{S3}$	1	Table B.5
	Coordinated SPDs	None	$P_{SPD}$	1	Table B.3
L1: Loss of human life		Special hazard: low panic	$h_z$	2	Table C.6
		D1: due to touch and step voltage	$L_T$	10 <sup>-2</sup>	Table C.2
		D2: due to physical damage	$L_F$	0,02	
		D3: due to failure of internal systems	$L_O$	–	
Factor for persons in zone		$n_z/n_t \times t_z/8\ 760 = 160/200 \times 8\ 760/8\ 760$	–	0,80	

**Table E.17 – Office building: Factors valid for zone Z<sub>5</sub> (computer centre)**

Input parameter		Comment	Symbol	Value	Reference
Type of floor		Linoleum	$r_t$	10 <sup>-5</sup>	Table C.3
Protection against shock (flash to structure)		None	$P_{TA}$	1	Table B.1
Protection against shock (flash to line)		None	$P_{TU}$	1	Table B.6
Risk of fire		Low	$r_f$	10 <sup>-3</sup>	Table C.5
Fire protection		None	$r_p$	1	Table C.4
Internal spatial shield		None	$K_{S2}$	1	Equation (B.6)
Power	Internal wiring	Unshielded (loop conductors in the same conduit)	$K_{S3}$	0,2	Table B.5
	Coordinated SPDs	None	$P_{SPD}$	1	Table B.3
Telecom	Internal wiring	Unshielded (large loops > 10 m <sup>2</sup> )	$K_{S3}$	1	Table B.5
	Coordinated SPDs	None	$P_{SPD}$	1	Table B.3
L1: Loss of human life		Special hazard: low panic	$h_z$	2	Table C.6
		D1: due to touch and step voltage	$L_T$	10 <sup>-2</sup>	Table C.2
		D2: due to physical damage	$L_F$	0,02	
		D3: due to failure of internal systems	$L_O$	–	
Factor for persons in zone		$n_z/n_t \times t_z/8\ 760 = 14/200 \times 8\ 760/8\ 760$	–	0,07	

### E.3.3 Calculation of relevant quantities

Calculations are given in Table E.18 for the collection areas and in Table E.19 for the expected number of dangerous events.

**Table E.18 – Office building: Collection areas of structure and lines**

	Symbol	Result m <sup>2</sup>	Reference Equation	Equation
Structure	$A_D$	$2,75 \times 10^4$	(A.2)	$A_D = L \times W + 2 \times (3 \times H) \times (L + W) + \pi \times (3 \times H)^2$
	$A_M$	–	(A.7)	Not relevant
Power line	$A_{L/P}$	$8,00 \times 10^3$	(A.9)	$A_{L/P} = 40 \times L_L$
	$A_{I/P}$	$8,00 \times 10^5$	(A.11)	Not relevant
	$A_{DA/P}$	0	(A.2)	No adjacent structure
Telecom line	$A_{L/T}$	$4,00 \times 10^4$	(A.9)	$A_{L/P} = 40 \times L_L$
	$A_{I/T}$	$4,00 \times 10^6$	(A.11)	Not relevant
	$A_{DA/T}$	0	(A.2)	No adjacent structure

**Table E.19 – Office building: Expected annual number of dangerous events**

	Symbol	Result 1/year	Reference Equation	Equation
Structure	$N_D$	$1,10 \times 10^{-1}$	(A.4)	$N_D = N_G \times A_D \times C_D \times 10^{-6}$
	$N_M$	–	(A.6)	Not relevant
Power line	$N_{L/P}$	$3,20 \times 10^{-2}$	(A.8)	$N_{L/P} = N_G \times A_{L/P} \times C_{I/P} \times C_{E/P} \times C_{T/P} \times 10^{-6}$
	$N_{I/P}$	3,20	(A.10)	Not relevant
	$N_{DA/P}$	0	(A.5)	No adjacent structure
Telecom line	$N_{L/T}$	$8,00 \times 10^{-2}$	(A.8)	$N_{L/T} = N_G \times A_{L/T} \times C_{I/T} \times C_{E/T} \times C_{T/T} \times 10^{-6}$
	$N_{I/T}$	8,00	(A.10)	Not relevant
	$N_{DA/T}$	0	(A.5)	No adjacent structure

### E.3.4 Risk $R_1$ – Decision on need for protection

Values of the risk components for the unprotected structure are reported in Table E.20.

**Table E.20 – Office building: Risk  $R_1$  for the unprotected structure (values  $\times 10^{-5}$ )**

Type of damage	Symbol	$Z_1$	$Z_2$	$Z_3$	$Z_4$	$Z_5$	Structure
D1 Injury due to shock	$R_A$	0,002	0	$\approx 0$	0,001	$\approx 0$	<b>0,003</b>
	$R_U = R_{U/P} + R_{U/T}$			$\approx 0$	0,001	$\approx 0$	<b>0,001</b>
D2 Physical damage	$R_B$			4,395	0,352	0,031	<b>4,778</b>
	$R_V = R_{V/P} + R_{V/T}$			4,480	0,358	0,031	<b>4,870</b>
<b>Total</b>		<b>0,002</b>	<b>0</b>	<b>8,876</b>	<b>0,712</b>	<b>0,062</b>	<b><math>R_1 = 9,65</math></b>
<b>Tolerable</b>		<b><math>R_1 &gt; R_T</math>: Lightning protection is required</b>					<b><math>R_T = 1</math></b>

Because  $R_1 = 9,65 \times 10^{-5}$  is higher than the tolerable value  $R_T = 10^{-5}$ , lightning protection for the structure is required.

### E.3.5 Risk $R_1$ – Selection of protection measures

The risk  $R_1$  in the structure is mainly concentrated in zone  $Z_3$  due to physical damages caused by lightning striking the structure or the connected lines (components  $R_B \approx 49\%$  and  $R_V \approx 50\%$  together cover 99% of the total risk) (see Table E.20).

These dominant risk components can be reduced by:

- providing the whole building with an LPS conforming to IEC 62305-3 reducing component  $R_B$  via probability  $P_B$ . Lightning equipotential bonding at the entrance – a mandatory requirement of the LPS - reduces also the components  $R_U$  and  $R_V$  via probability  $P_{EB}$ ;
- providing zone  $Z_3$  (archive) with protection measures against the consequences of fire (such as extinguishers, automatic fire detection system etc.). This will reduce the components  $R_B$  and  $R_V$  via the reduction factor  $r_p$ ;
- providing lightning equipotential bonding conforming to IEC 62305-3 at the entrance of the building. This will reduce only the components  $R_U$  and  $R_V$  via probability  $P_{EB}$ .

Combining different elements of these protective measures the following solutions could be adopted:

#### Solution a)

- Protect the building with a Class III LPS conforming to IEC 62305-3, to reduce component  $R_B$  ( $P_B = 0,1$ ).

- This LPS includes the mandatory lightning equipotential bonding at the entrance with SPDs designed for LPL III ( $P_{EB} = 0,05$ ) and reduces components  $R_U$  and  $R_V$ .

Solution b)

- Protect the building with a Class IV LPS conforming to IEC 62305-3, to reduce component  $R_B$  ( $P_B = 0,2$ ).
- This LPS includes the mandatory lightning equipotential bonding at the entrance with SPDs designed for LPL IV ( $P_{EB} = 0,05$ ) and reduces components  $R_U$  and  $R_V$ .
- Use fire extinguishing (or detection) systems to reduce components  $R_B$  and  $R_V$ . Install a manual system in the zone Z3 (archive) ( $r_p = 0,5$ ).

For both solutions, the risk values from Table E.20 will change to the reduced values reported in Table E.21.

**Table E.21 – Office building: Risk  $R_1$  for the protected structure (values  $\times 10^{-5}$ )**

	$Z_1$	$Z_2$	$Z_3$	$Z_4$	$Z_5$	Total	Tolerable	Result
Solution a)	$\approx 0$	0	0,664	0,053	0,005	$R_1 = 0,722$	$R_T = 1$	$R_1 \leq R_T$
Solution b)	$\approx 0$	0	0,552	0,089	0,008	$R_1 = 0,648$	$R_T = 1$	$R_1 \leq R_T$

Both solutions reduce the risk below the tolerable value. The solution to be adopted is subject to both the best technical criteria and the most cost-effective solution.

## E.4 Hospital

As a more complex case, this study considers a standard hospital facility with a rooms block, an operating block and an intensive care unit.

Loss of human life (L1) and economic loss (L4) are relevant for this type of facility. It is necessary to evaluate the need for protection and the cost effectiveness of protection measures; these require the evaluation of risks  $R_1$  and  $R_4$ .

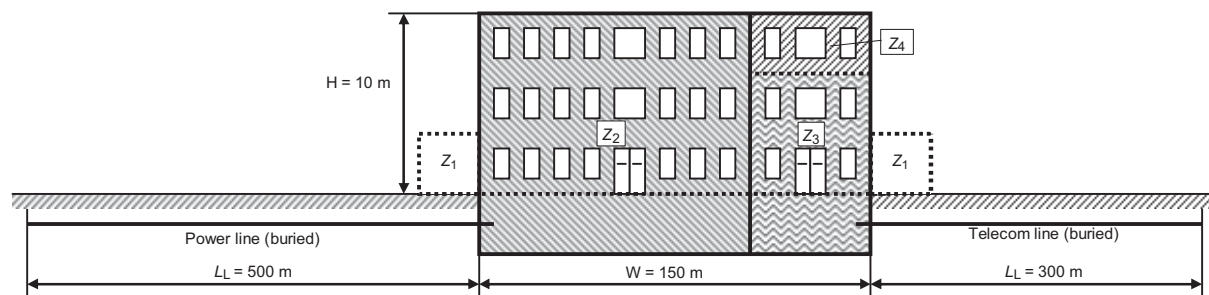

IEC 2644/10

### Key

- $Z_1$ : outside
- $Z_2$ : rooms block
- $Z_3$ : operation block
- $Z_4$ : intensive care unit

**Figure E.3 – Hospital**

### E.4.1 Relevant data and characteristics

The hospital is located in flat territory without any neighbouring structures. The lightning flash density is  $N_G = 4$  flashes per km<sup>2</sup> per year.

Data for the building and its surroundings are given in Table E.22.

Data for the incoming lines and their internal systems connected thereto are given for the power line in Table E.23 and for the telecom line in Table E.24.

**Table E.22 – Hospital: Environment and global structure characteristics**

Input parameter	Comment	Symbol	Value	Reference
Ground flash density (1/km <sup>2</sup> /year)		$N_G$	4,0	
Structure dimensions (m)		$L, W, H$	50, 150, 10	
Location factor of structure	Isolated structure	$C_D$	1	Table A.1
LPS	None	$P_B$	1	Table B.2
Equipotential bonding	None	$P_{EB}$	1	Table B.7
External spatial shield	None	$K_{S1}$	1	Equation (B.5)

**Table E.23 – Hospital: Power line**

Input parameter	Comment	Symbol	Value	Reference
Length (m)		$L_L$	500	
Installation factor	Buried	$C_I$	0,5	Table A.2
Line type factor	HV power (with HV/LV transformer)	$C_T$	0,2	Table A.3
Environmental factor	Suburban	$C_E$	0,5	Table A.4
Shield of line ( $\Omega$ /km)	Line shield bonded to the same bonding bar as equipment	$R_S$	$R_S \leq 1$	Table B.8
Shielding, grounding, isolation	Line shield bonded to the same bonding bar as equipment	$C_{LD}$	1	Table B.4
		$C_{LI}$	0	
Adjacent structure (m)	None	$L_J, W_J, H_J$	–	
Location factor of adjacent structure	None	$C_{DJ}$	–	Table A.1
Withstand voltage of internal system (kV)		$U_W$	2,5	
	Resulting parameters	$K_{S4}$	0,4	Equation (B.7)
		$P_{LD}$	0,2	Table B.8
		$P_{LI}$	0,3	Table B.9

**Table E.24 – Hospital: Telecom line**

Input parameter	Comment	Symbol	Value	Reference
Length (m)		$L_L$	300	
Installation factor	Buried	$C_I$	0,5	Table A.2
Line type factor	Telecom line	$C_T$	1	Table A.3
Environmental factor	Suburban	$C_E$	0,5	Table A.4
Shield of line ( $\Omega$ /km)	Line shield bonded to the same bonding bar as equipment.	$R_S$	$1 < R_S \leq 5$	Table B.8
Shielding, grounding, isolation	Line shield bonded to the same	$C_{LD}$	1	Table B.4

Input parameter	Comment	Symbol	Value	Reference
	bonding bar as equipment.	$C_{LI}$	0	
Adjacent structure (m)	Length, width, height	$L_J, W_J, H_J$	20, 30, 5	
Location factor of adjacent structure	Isolated structure	$C_{DJ}$	1	Table A.1
Withstand voltage of internal system (kV)		$U_W$	1,5	
	Resulting parameters	$K_{S4}$	0,67	Equation (B.7)
		$P_{LD}$	0,8	Table B.8
		$P_{LI}$	0,5	Table B.9

#### E.4.2 Definition of zones in the hospital

The following zones are defined:

- $Z_1$  (outside building);
- $Z_2$  (rooms block);
- $Z_3$  (operating block);
- $Z_4$  (intensive care unit);

taking into account the following:

- the type of surface is different outside the structure from that inside the structure;
- two separate fire proof compartments exist: the first is the rooms block ( $Z_2$ ) and the second is the operating block together with the intensive care unit ( $Z_3$  and  $Z_4$ );
- in all inner zones  $Z_2$ ,  $Z_3$  and  $Z_4$ , internal systems connected to power as well as to telecom lines exist;
- no spatial shields exist;
- the intensive care unit contains extensive sensitive electronic systems and a spatial shield may be adopted as protection measure;

In the different zones inside and outside the hospital a total number of 1 000 persons shall be considered.

The number of persons, the times of presence and the economic values related to each zone are different. The distribution into the individual zones and the total values are shown in Table E.25. These values are used later to subdivide the total loss values into fractions for each zone.

**Table E.25 – Hospital: Distribution of persons and of economic values into zones**

Zone	Number of persons	Time of presence (h/y)	Economic values in \$ x 10 <sup>6</sup>				
			Animals $c_a$	Building $c_b$	Content $c_c$	Internal systems $c_s$	Total $c_t$
$Z_1$ (outside building)	10	8 760	–	–	–	–	–
$Z_2$ (rooms block)	950	8 760	–	70	6	3,5	<b>79,5</b>
$Z_3$ (operating block)	35	8 760	–	2	0,9	5,5	<b>8,4</b>
$Z_4$ (intensive care unit)	5	8 760	–	1	0,1	1,0	<b>2,1</b>
<b>Total</b>	$n_t = 1\ 000$	–	<b>0</b>	<b>73</b>	<b>7</b>	<b>10</b>	<b>90,0</b>

For risk  $R_1$ , following the evaluation by the lightning protection designer, the basic loss values (typical mean values of relative amount of loss per year) according to Table C.2 and the increasing factor for special hazards according to Table C.6 are as follows:

- $L_T = 10^{-2}$  in zone  $Z_1$  outside the structure;
- $L_T = 10^{-2}$  in zones  $Z_2, Z_3, Z_4$  inside the structure;
- $L_F = 10^{-1}$  in zones  $Z_2, Z_3, Z_4$  inside the structure;
- $h_z = 5$  in zones  $Z_2, Z_3, Z_4$  inside the structure due to difficulty of evacuation;
- $L_O = 10^{-3}$  in zone  $Z_2$  (rooms block);
- $L_O = 10^{-2}$  in zone  $Z_3$  (operating block) and zone  $Z_4$  (intensive care unit).

These basic loss values were reduced for each zone according to the Equations (C.1) to (C.4) taking into account the number of people endangered in the individual zone related to the total number of people considered and the time when people are present.

For risk  $R_4$  the basic loss values according to Table C.12 are as follows:

- $L_T = 0$  no animals endangered;
- $L_F = 0,5$  in zones  $Z_2, Z_3, Z_4$  inside the structure;
- $L_O = 10^{-2}$  in zones  $Z_2, Z_3, Z_4$  inside the structure.

These basic loss values were reduced for each zone according to Equations (C.11) to (C.13) taking into account the value endangered in the individual zone related to the total value of the structure (animals, building, content, internal systems and activities) considered. The value endangered in an individual zone depends on the type of damage:

- D1 (injury by electric shock): value  $c_a$  of animals only;
- D2 (physical damage): sum of all values  $c_a + c_b + c_c + c_s$ ;
- D3 (failure of internal system): value  $c_s$  of internal systems and their activities only.

The resulting characteristics of the zones  $Z_1$  to  $Z_4$  are given in Tables E.26 to E.29.

**Table E.26 – Hospital: Factors valid for zone  $Z_1$  (outside the building)**

Input parameter	Comment	Symbol	Value	Reference
Ground surface	Concrete	$r_t$	$10^{-2}$	Table C.3
Protection against shock	None	$P_{TA}$	1	Table B.1
Risk of fire	None	$r_f$	0	Table C.5
Fire protection	None	$r_p$	1	Table C.4
Internal spatial shield	None	$K_{S2}$	1	Equation (B.6)
L1: Loss of human life	Special hazard: None	$h_z$	1	Table C.5
	D1: due to touch and step voltage	$L_T$	$10^{-2}$	Table C.2
	D2: due to physical damage	$L_F$	0	
	D3: due to failure of internal systems	$L_O$	0	
Factor for persons in zone	$n_z / n_t \times t_z / 8\,760 = 10 / 1\,000 \times 8\,760 / 8\,760$	–	0,01	

**Table E.27 – Hospital: Factors valid for zone  $Z_2$  (rooms block)**

Input parameter	Comment	Symbol	Value	Reference
Type of floor	Linoleum	$r_t$	$10^{-5}$	Table C.3
Protection against shock (flash to structure)	None	$P_{TA}$	1	Table B.1



Input parameter		Comment	Symbol	Value	Reference
Protection against shock (flash to line)		None	$P_{TU}$	1	Table B.9
Risk of fire		Ordinary	$r_f$	$10^{-2}$	Table C.5
Fire protection		None	$r_p$	1	Table C.4
Internal spatial shield		None	$K_{S2}$	1	Equation (B.6)
Power	Internal wiring	Unshielded (loop conductors in the same conduit)	$K_{S3}$	0,2	Table B.5
	Coordinated SPDs	None	$P_{SPD}$	1	Table B.3
Telecom	Internal wiring	Unshielded (loop conductors in the same cable)	$K_{S3}$	0,01	Table B.5
	Coordinated SPDs	None	$P_{SPD}$	1	Table B.3
L1: Loss of human life		Special hazard: difficulty of evacuation	$h_z$	5	Table C.6
		D1: due to touch and step voltage	$L_T$	$10^{-2}$	Table C.2
		D2: due to physical damage	$L_F$	$10^{-1}$	
		D3: due to failure of internal systems	$L_O$	$10^{-3}$	
Factor for persons in zone		$n_z / n_t \times t_z / 8\,760 = 950 / 1\,000 \times 8\,760 / 8\,760$	–	0,95	
L4: Economic loss		D2: due to physical damage	$L_F$	0,5	Table C.12
		D2: Factor $(c_a + c_b + c_c + c_s) / c_t = 79,5 / 90$	–	0,883	
		D3: due to failure of internal systems	$L_O$	$10^{-2}$	
		D3: Factor $c_s / c_t = 3,5 / 90$	–	0,039	

Table E.28 – Hospital: Factors valid for zone  $Z_3$  (operating block)

Input parameter		Comment	Symbol	Value	Reference
Type of floor		Linoleum	$r_t$	$10^{-5}$	Table C.3
Protection against shock (flash to structure)		None	$P_{TA}$	1	Table B.1
Protection against shock (flash to line)		None	$P_{TU}$	1	Table B.9
Risk of fire		Low	$r_f$	$10^{-3}$	Table C.5
Fire protection		None	$r_p$	1	Table C.4
Internal spatial shield		None	$K_{S2}$	1	Equation (B.6)
Power line	Internal wiring	Unshielded (loop conductors in the same conduit)	$K_{S3}$	0,2	Table B.5
	Coordinated SPDs	None	$P_{SPD}$	1	Table B.3
Telecom line	Internal wiring	Unshielded (loop conductors in the same cable)	$K_{S3}$	0,01	Table B.5
	Coordinated SPDs	None	$P_{SPD}$	1	Table B.3
L1: Loss of human life		Special hazard: difficulty of evacuation	$h_z$	5	Table C.6
		D1: due to touch and step voltage	$L_T$	$10^{-2}$	Table C.2
		D2: due to physical damage	$L_F$	$10^{-1}$	
		D3: due to failure of internal systems	$L_O$	$10^{-2}$	
Factor for persons in zone		$n_z / n_t \times t_z / 8\,760 = 35 / 1\,000 \times 8\,760 / 8\,760$	–	0,035	
L4: Economic loss		D2: due to physical damage	$L_F$	0,5	Table C.12
		D2: Factor $(c_a + c_b + c_c + c_s) / c_t = 8,4 / 90$	–	0,093	
		D3: due to failure of internal systems	$L_O$	$10^{-2}$	
		D3: Factor $c_s / c_t = 5,5 / 90$	–	0,061	

**Table E.29 – Hospital: Factors valid for zone Z<sub>4</sub> (intensive care unit)**

Input parameter		Comment	Symbol	Value	Reference
Type of floor		Linoleum	$r_t$	$10^{-5}$	Table C.3
Protection against shock (flash to structure)		None	$P_{TA}$	1	Table B.1
Protection against shock (flash to line)		None	$P_{TU}$	1	Table B.9
Risk of fire		Low	$r_f$	$10^{-3}$	Table C.5
Fire protection		None	$r_p$	1	Table C.4
Internal spatial shield		None	$K_{S2}$	1	Equation (B.6)
Power Line	Internal wiring	Unshielded (loop conductors in the same conduit)	$K_{S3}$	0,2	Table B.5
	Coordinated SPDs	None	$P_{SPD}$	1	Table B.3
Telecom Line	Internal wiring	Unshielded (loop conductors in the same cable)	$K_{S3}$	0,01	Table B.5
	Coordinated SPDs	None	$P_{SPD}$	1	Table B.3
L1: Loss of human life		Special hazard: difficulty of evacuation	$h_z$	5	Table C.6
		D1: due to touch and step voltage	$L_T$	$10^{-2}$	Table C.2
		D2: due to physical damage	$L_F$	$10^{-1}$	
		D3: due to failure of internal systems	$L_O$	$10^{-2}$	
Factor for persons in zone		$n_z / n_t \times t_z / 8\ 760 = 5 / 1\ 000 \times 8\ 760 / 8\ 760$	-	0,005	
L4: Economic loss		D2: due to physical damage	$L_F$	0,5	Table C.12
		D2: Factor $(c_a + c_b + c_c + c_s) / c_t = 2,1 / 90$	-	0,023	
		D3: due to failure of internal systems	$L_O$	$10^{-2}$	
		D3: Factor $c_s / c_t = 1,0 / 90$	-	0,011	

### E.4.3 Calculation of relevant quantities

Calculations are given in Table E.30 for the collection areas and in Table E.31 for the expected number of dangerous events.

**Table E.30 – Hospital: Collection areas of structure and lines**

	Symbol	Result m <sup>2</sup>	Reference Equation	Equation
Structure	$A_D$	$2,23 \times 10^4$	(A.2)	$A_D = L \times W + 2 \times (3 \times H) \times (L + W) + \pi \times (3 \times H)^2$
	$A_M$	$9,85 \times 10^5$	(A.7)	$A_M = 2 \times 500 \times (L+W) + \pi \times 500^2$
Power line	$A_{L/P}$	$2,00 \times 10^4$	(A.9)	$A_{L/P} = 40 \times L_L$
	$A_{I/P}$	$2,00 \times 10^6$	(A.11)	$A_{L/P} = 4\ 000 \times L_L$
	$A_{DJ/P}$	0	(A.2)	No adjacent structure
Telecom line	$A_{L/T}$	$1,20 \times 10^4$	(A.9)	$A_{L/P} = 40 \times L_L$
	$A_{I/T}$	$1,20 \times 10^6$	(A.11)	$A_{L/P} = 4\ 000 \times L_L$
	$A_{DJ/T}$	$2,81 \times 10^3$	(A.2)	$A_{DJ/T} = L_J \times W_J + 2 \times (3 \times H_J) \times (L_J + W_J) + \pi \times (3 \times H_J)^2$

**Table E.31 – Hospital: Expected annual number of dangerous events**

	Symbol	Result 1/year	Reference Equation	Equation
Structure	$N_D$	$8,93 \times 10^{-2}$	(A.4)	$N_D = N_G \times A_{D/B} \times C_{D/B} \times 10^{-6}$
	$N_M$	3,94	(A.6)	$N_M = N_G \times A_M \times 10^{-6}$
Power line	$N_{L/P}$	$4,00 \times 10^{-3}$	(A.8)	$N_{L/P} = N_G \times A_{L/P} \times C_{I/P} \times C_{E/P} \times C_{T/P} \times 10^{-6}$
	$N_{I/P}$	$4,00 \times 10^{-1}$	(A.10)	$N_{I/P} = N_G \times A_{I/P} \times C_{I/P} \times C_{E/P} \times C_{T/P} \times 10^{-6}$
	$N_{DJ/P}$	0	(A.5)	No adjacent structure
Telecom line	$N_{L/T}$	$1,20 \times 10^{-2}$	(A.8)	$N_{L/T} = N_G \times A_{L/T} \times C_{I/T} \times C_{E/T} \times C_{T/T} \times 10^{-6}$
	$N_{I/T}$	1,20	(A.10)	$N_{I/T} = N_G \times A_{I/T} \times C_{I/T} \times C_{E/T} \times C_{T/T} \times 10^{-6}$
	$N_{DJ/T}$	$1,12 \times 10^{-2}$	(A.5)	$N_{DJ/T} = N_G \times A_{DJ/T} \times C_{DJ/T} \times C_{T/T} \times 10^{-6}$

**E.4.4 Risk  $R_1$  – Decision on need for protection**

Values of the probabilities  $P_X$  are given in Table E.32 and the risk components for the unprotected structure are reported in Table E.33.

**Table E.32 – Hospital: Risk  $R_1$  – Values of probability  $P$  for the unprotected structure**

Type of damage	Symbol	$Z_1$	$Z_2$	$Z_3$	$Z_4$	Reference Equation	Equation
D1 Injury due to shock	$P_A$	1		1			
	$P_{U/P}$			0,2			
	$P_{U/T}$			0,8			
D2 Physical damage	$P_B$			1			
	$P_{V/P}$			0,2			
	$P_{V/T}$			0,8			
D3 Failure of internal systems	$P_C$			1		(14)	$P_C = 1 - (1 - P_{C/P}) \times (1 - P_{C/T}) =$ $= 1 - (1 - 1) \times (1 - 1)$
	$P_M$			0,0064		(15)	$P_M = 1 - (1 - P_{M/P}) \times (1 - P_{M/T}) =$ $= 1 - (1 - 0,0064) \times (1 - 0,00004)$
	$P_{W/P}$			0,2			
	$P_{W/T}$			0,8			
	$P_{Z/P}$			0			
	$P_{Z/T}$			0			

**Table E.33 – Hospital: Risk  $R_1$  for the unprotected structure (values  $\times 10^{-5}$ )**

Type of damage	Symbol	$Z_1$	$Z_2$	$Z_3$	$Z_4$	Structure
D1 Injury due to shock	$R_A$	0,009	0,0009	$\approx 0$	$\approx 0$	<b>0,010</b>
	$R_U = R_{U/P} + R_{U/T}$		$\approx 0$	$\approx 0$	$\approx 0$	$\approx 0$
D2 Physical damage	$R_B$		42,4	0,156	0,022	<b>42,6</b>
	$R_V = R_{V/P} + R_{V/T}$		9,21	0,034	0,005	<b>9,245</b>
D3 Failure of internal	$R_C$		8,484	3,126	0,447	<b>12,057</b>
	$R_M$		2,413	0,889	0,127	<b>3,429</b>

Type of damage	Symbol	Z <sub>1</sub>	Z <sub>2</sub>	Z <sub>3</sub>	Z <sub>4</sub>	Structure
systems	$R_W = R_{W/P} + R_{W/T}$		1,841	0,678	0,097	<b>2,616</b>
	$R_Z = R_{Z/P} + R_{Z/T}$					
<b>Total</b>		<b>0,009</b>	<b>64,37</b>	<b>4,89</b>	<b>0,698</b>	<b>R<sub>1</sub> = 69,96</b>
<b>Tolerable</b>		<b>R<sub>1</sub> &gt; R<sub>T</sub>: Lightning protection is required</b>				<b>R<sub>T</sub> = 1</b>

Because  $R_1 = 69,96 \times 10^{-5}$  is higher than the tolerable value  $R_T = 10^{-5}$ , lightning protection for the structure is required.

#### E.4.5 Risk R<sub>1</sub> – Selection of protection measures

The risk R<sub>1</sub> is mainly influenced (see Table E.33):

- by physical damage in the zone Z<sub>2</sub> (components R<sub>B</sub> ≈ 61 % and R<sub>V</sub> ≈ 13 % of the total risk);
- by failures of internal systems in the zones Z<sub>2</sub> and Z<sub>3</sub> (components R<sub>C</sub> ≈ 12 % respectively R<sub>C</sub> ≈ 5 %) of the total risk.

These dominant risk components can be reduced by:

- providing the whole building with an LPS conforming to IEC 62305-3 reducing component R<sub>B</sub> via probability P<sub>B</sub>. The mandatory-included lightning equipotential bonding at the entrance reduces also the components R<sub>U</sub> and R<sub>V</sub> via probability P<sub>EB</sub>;
- providing zone Z<sub>2</sub> with protection measures against the consequences of fire (such as extinguishers, automatic fire detection system, etc.). This will reduce the components R<sub>B</sub> and R<sub>V</sub> via the reduction factor r<sub>p</sub>;
- providing zones Z<sub>3</sub> and Z<sub>4</sub> with a coordinated SPD protection conforming to IEC 62305-4 for the internal power and telecom systems. This will reduce the components R<sub>C</sub>, R<sub>M</sub>, R<sub>W</sub> via the probability P<sub>SPD</sub>.
- providing zones Z<sub>3</sub> and Z<sub>4</sub> with an adequate spatial grid-like shield conforming to IEC 62305-4. This will reduce the component R<sub>M</sub> via the probability P<sub>M</sub>.

Combining different elements of these protective measures the following solutions could be adopted:

Solution a)

- protect the building with a Class I LPS (P<sub>B</sub> = 0,02 including also P<sub>EB</sub> = 0,01);
- install coordinated SPD protection on internal power and telecom systems for (1,5 x) better than LPL I (P<sub>SPD</sub> = 0,005) in zones Z<sub>2</sub>, Z<sub>3</sub>, Z<sub>4</sub>;
- provide zone Z<sub>2</sub> with an automatic fire protection system (r<sub>p</sub> = 0,2 for zone Z<sub>2</sub> only);
- provide zone Z<sub>3</sub> and Z<sub>4</sub> with a meshed shield with w<sub>m</sub> = 0,5 m.

Using this solution, the risk values from Table E.33 will change to the reduced values reported in Table E.34.

**Table E.34 – Hospital: Risk  $R_1$  for the protected structure according to solution a)**  
(values  $\times 10^{-5}$ )

Type of damage	Symbol	$Z_1$	$Z_2$	$Z_3$	$Z_4$	Structure
D1 Injury due to shock	$R_A$	$\approx 0$	$\approx 0$	$\approx 0$	$\approx 0$	$\approx 0$
	$R_U = R_{U/P} + R_{U/T}$		$\approx 0$	$\approx 0$	$\approx 0$	$\approx 0$
D2 Physical damage	$R_B$		0,170	0,003	$\approx 0$	<b>0,173</b>
	$R_V = R_{V/P} + R_{V/T}$		0,018	$\approx 0$	$\approx 0$	<b>0,018</b>
D3 Failure of internal systems	$R_C$		0,085	0,031	0,004	<b>0,12</b>
	$R_M$		0,012	$\approx 0$	$\approx 0$	<b>0,012</b>
	$R_W = R_{W/P} + R_{W/T}$		0,009	0,003	$\approx 0$	<b>0,004</b>
	$R_Z = R_{Z/P} + R_{Z/T}$					
<b>Total</b>		$\approx 0$	<b>0,294</b>	<b>0,038</b>	<b>0,005</b>	$R_1 = 0,338$
<b>Tolerable</b>		$R_1 < R_T$ : Structure is protected for this type of loss				$R_T = 1$

Solution b)

- Protect the building with a Class I LPS ( $P_B = 0,02$  including also  $P_{EB} = 0,01$ ).
- Install coordinated SPD protection on internal power and telecom systems for (3 x) better than LPL I ( $P_{SPD} = 0,001$ ) in zones  $Z_2, Z_3, Z_4$ .
- Provide zone  $Z_2$  with an automatic fire protection system ( $r_p = 0,2$  for zone  $Z_2$  only).

Using this solution, the risk values from Table E.33 will change to the reduced values reported in Table E.35.

**Table E.35 – Hospital: Risk  $R_1$  for the protected structure according to solution b)**  
(values  $\times 10^{-5}$ )

Type of damage	Symbol	$Z_1$	$Z_2$	$Z_3$	$Z_4$	Structure
D1 Injury due to shock	$R_A$	$\approx 0$	$\approx 0$	$\approx 0$	$\approx 0$	$\approx 0$
	$R_U = R_{U/P} + R_{U/T}$		$\approx 0$	$\approx 0$	$\approx 0$	$\approx 0$
D2 Physical damage	$R_B$		0,170	0,003	0,001	<b>0,174</b>
	$R_V = R_{V/P} + R_{V/T}$		0,018	$\approx 0$	$\approx 0$	<b>0,018</b>
D3 Failure of internal systems	$R_C$		0,017	0,006	0,001	<b>0,024</b>
	$R_M$		0,002	0,001	$\approx 0$	<b>0,003</b>
	$R_W = R_{W/P} + R_{W/T}$		0,002	0,001	$\approx 0$	<b>0,003</b>
	$R_Z = R_{Z/P} + R_{Z/T}$					
<b>Total</b>		$\approx 0$	<b>0,209</b>	<b>0,011</b>	<b>0,002</b>	$R_1 = 0,222$
<b>Tolerable</b>		$R_1 < R_T$ : Structure is protected for this type of loss				$R_T = 1$

Solution c)

- Protect the building with a Class I LPS ( $P_B = 0,02$  including also  $P_{EB} = 0,01$ ).
- Install coordinated SPD protection on internal power and telecom systems for (2 x) better than LPL I ( $P_{SPD} = 0,002$ ) in zones  $Z_2, Z_3, Z_4$ .
- Provide zone  $Z_2$  with an automatic fire protection system ( $r_p = 0,2$  for zone  $Z_2$  only).
- Provide zone  $Z_3$  and  $Z_4$  with a meshed shield with  $w_m = 0,1\text{m}$ .

Using this solution, the risk values from Table E.33 will change to the reduced values reported in Table E.36.

**Table E.36 – Hospital: Risk  $R_1$  for the protected structure according to solution c) (values  $\times 10^{-5}$ )**

Type of damage	Symbol	Z <sub>1</sub>	Z <sub>2</sub>	Z <sub>3</sub>	Z <sub>4</sub>	Structure
D1 Injury due to shock	$R_A$	≈ 0	≈ 0	≈ 0	≈ 0	≈ 0
	$R_U = R_{U/P} + R_{U/T}$		≈ 0	≈ 0	≈ 0	≈ 0
D2 Physical damage	$R_B$		0,170	0,003	≈ 0	<b>0,173</b>
	$R_V = R_{V/P} + R_{V/T}$		0,018	≈ 0	≈ 0	<b>0,018</b>
D3 Failure of internal systems	$R_C$		0,034	0,012	0,002	<b>0,048</b>
	$R_M$		≈ 0	≈ 0	≈ 0	≈ 0
	$R_W = R_{W/P} + R_{W/T}$		0,004	0,001	≈ 0	<b>0,005</b>
	$R_Z = R_{Z/P} + R_{Z/T}$					
<b>Total</b>		≈ 0	<b>0,226</b>	<b>0,016</b>	<b>0,002</b>	<b><math>R_1 = 0,244</math></b>
<b>Tolerable</b>		<b><math>R_1 &lt; R_T</math>: Structure is protected for this type of loss</b>				<b><math>R_T = 1</math></b>

All solutions reduce the risk below the tolerable level. The solution to be adopted is subject to both the best technical criteria and the most cost-effective solution.

**E.4.6 Risk  $R_4$  – Cost benefit analysis**

For the economic loss L4 the corresponding risk  $R_4$  can be evaluated in the same way as before. All parameters required for evaluating the risk components are given in Tables E.22 through E.29, where the loss values  $L_X$  for economic loss L4 only are valid. Therefore only the zones Z<sub>2</sub>, Z<sub>3</sub> and Z<sub>4</sub> are relevant, whereas zone Z<sub>1</sub> is disregarded (It could be relevant only in case of loss of animals).

The economic values (animals, building, internal systems and activities) were given above in Table E.25 for each zone and in total.

From the risk values  $R_4$  or  $R'_4$  and from the total value of the structure  $c_t = 90 \times 10^6$  \$ (Table E.25) the annual cost of loss  $C_L = R_4 \times c_t$  for the unprotected and  $C_{RL} = R'_4 \times c_t$  for the protected structure can be calculated (see Equation (D.2) and (D.4)). The results are shown in Table E.37.

**Table E.37 – Hospital: Cost of loss  $C_L$ (unprotected) and  $C_{RL}$ (protected)**

Protection	Risk $R_4$ values $\times 10^{-5}$					Cost of loss \$
	Z <sub>1</sub>	Z <sub>2</sub>	Z <sub>3</sub>	Z <sub>4</sub>	Structure	$C_L$ or $C_{RL}$
Unprotected	–	53,2	8,7	1,6	<b>63,5</b>	<b>57 185</b>
Solution a)	–	0,22	0,07	0,01	<b>0,30</b>	<b>271</b>
Solution b)	–	0,18	0,02	0,005	<b>0,21</b>	<b>190</b>
Solution c)	–	0,19	0,03	0,007	<b>0,23</b>	<b>208</b>

The values assumed for interest, amortization and maintenance rates relevant to the protection measures are given in Table E.38.

**Table E.38 – Hospital: Rates relevant to the protection measures**

Rate	Symbol	Value
Interest	$i$	0,04
Amortization	$a$	0,05
Maintenance	$m$	0,01

A list of cost  $C_P$  for possible protection measures and the annual cost  $C_{PM}$  of the protection measures adopted in solution a), b) or c) are given in Table E.39 (see Equation (D.5)).

**Table E.39 – Hospital: Cost  $C_P$  and  $C_{PM}$  of protection measures (values in \$)**

Protection measure	Cost $C_P$	Annual cost $C_{PM} = C_P (I + a + m)$		
		Solution a)	Solution b)	Solution c)
LPS class I	100 000	10 000	10 000	10 000
Automatic fire protection in zone $Z_2$	50 000	5 000	5 000	5 000
Zones $Z_3$ and $Z_4$ shielding ( $w = 0,5$ m)	100 000	10 000		
Zones $Z_3$ and $Z_4$ shielding ( $w = 0,1$ m)	110 000			11 000
SPD on power system ( $1,5 \times$ LPL I)	20 000	2 000		
SPD on power system ( $2 \times$ LPL I)	24 000			2 400
SPD on power system ( $3 \times$ LPL I)	30 000		3 000	
SPD on TLC system ( $1,5 \times$ LPL I)	10 000	1 000		
SPD on TLC system ( $2 \times$ LPL I)	12 000			1 200
SPD on TLC system ( $3 \times$ LPL I)	15 000		1 500	
<b>Total annual cost <math>C_{PM}</math></b>		<b>28 000</b>	<b>19 500</b>	<b>29 600</b>

The annual saving of money  $S_M$  can be evaluated by comparison of the annual cost of loss  $C_L$  for the unprotected structure with the sum of the residual annual cost of loss  $C_{RL}$  for the protected structure and the annual cost of the protection measures  $C_{PM}$ . The results for solution a), b) and c) are given in Table E.40.

**Table E.40 – Hospital: Annual saving of money (values in \$)**

	Symbol	Solution a)	Solution b)	Solution c)
Loss for the unprotected structure	$C_L$	57 185	57 185	57 185
Residual loss for the protected structure	$C_{RL}$	271	190	208
Annual cost of protection	$C_{PM}$	28 000	19 500	29 600
<b>Annual saving <math>S_M = C_L - (C_{RL} + C_{PM})</math></b>	$S_M$	<b>28 914</b>	<b>37 495</b>	<b>27 377</b>

## E.5 Apartment block

This case study compares different solutions for lightning protection for an apartment block. The results show that some solutions may not be sufficient, whereas several suitable solutions can be chosen from different combinations of protection measures.

Only the risk  $R_1$  for loss of human life (L1) with the risk components  $R_A$ ,  $R_B$ ,  $R_U$  and  $R_V$  (according Table 2) will be determined and compared with the tolerable value  $R_T = 10^{-5}$  (according to Table 4). Economic evaluation is not required, therefore the risk  $R_4$  for economic loss (L4) is not considered.

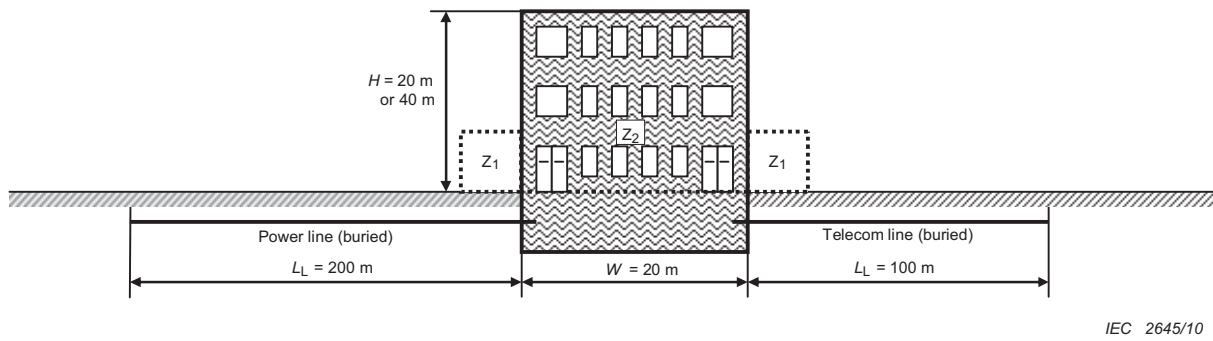

**Key**

- Z<sub>1</sub>: outside
- Z<sub>2</sub>: inside

**Figure E.4 – Apartment block**

**E.5.1 Relevant data and characteristics**

The apartment block is located in flat territory without any neighboring structures. The lightning flash density is  $N_G = 4$  flashes per km<sup>2</sup> per year. 200 persons live in the block. This is also the total number of persons to be considered, because outside the building no people are assumed to be present during a thunderstorm.

Data for the block and its surroundings are given in Table E.41.

Data for the incoming lines and their internal systems connected to are given for the power line in Table E.42 and for the telecom line in Table E.43.

**Table E.41 – Apartment block: Environment and global structure characteristics**

Input parameter	Comment	Symbol	Value	Reference
Ground flash density (1/km <sup>2</sup> /year)		$N_G$	4,0	
Structure dimensions (m)	$H = 20$ or $40$ (see Table E.45)	$L, W$	30, 20	
Location factor of structure	Isolated structure	$C_D$	1	Table A.1
LPS	Variable (see Table E.45)	$P_B$	–	Table B.2
Equipotential bonding	None	$P_{EB}$	1	Table B.7
External spatial shield	None	$K_{S1}$	1	Equation (B.5)

**Table E.42 – Apartment block: Power line**

Input parameter	Comment	Symbol	Value	Reference
Length (m)		$L_L$	200	
Installation factor	Buried	$C_I$	0,5	Table A.2
Line type factor	LV line	$C_T$	1	Table A.3
Environmental factor	Suburban	$C_E$	0,5	Table A.4
Shield of line (Ω/km)	Unshielded	$R_S$	–	Table B.8
Shielding, grounding, isolation	None	$C_{LD}$	1	Table B.4
		$C_{LI}$	1	
Adjacent structure (m)	None	$L_J, W_J, H_J$	–	
Location factor of adjacent	None	$C_{DJ}$	–	Table A.1



Input parameter	Comment	Symbol	Value	Reference
structure				
Withstand voltage of internal system (kV)		$U_W$	2,5	
	Resulting parameters	$K_{S4}$	0,4	Equation (B.7)
		$P_{LD}$	1	Table B.8
		$P_{LI}$	0,3	Table B.9

Table E.43 – Apartment block: Telecom line

Input parameter	Comment	Symbol	Value	Reference
Length (m)		$L_L$	100	
Installation factor	Buried	$C_1$	0,5	Table A.2
Line type factor	Telecom line	$C_T$	1	Table A.3
Environmental factor	Suburban	$C_E$	0,5	Table A.4
Shield of line ( $\Omega/\text{km}$ )	Unshielded	$R_S$	–	Table B.8
Shielding, grounding, isolation	None	$C_{LD}$	1	Table B.4
		$C_{LI}$	1	
Adjacent structure (m)	None	$L_J, W_J, H_J$	–	
Location factor of adjacent structure	None	$C_{DJ}$	–	Table A.1
Withstand voltage of internal system (kV)		$U_W$	1,5	
	Resulting parameters	$K_{S4}$	0,67	Equation (B.7)
		$P_{LD}$	1	Table B.8
		$P_{LI}$	0,5	Table B.9

### E.5.2 Definition of zones in the apartment block

The following zones may be defined:

- $Z_1$  (outside the building);
- $Z_2$  (inside the building).

For zone  $Z_1$  it is assumed that no people are outside the building. Therefore the risk of shock to people  $R_A = 0$ . Because  $R_A$  is the only risk component outside the building, zone  $Z_1$  can be disregarded completely.

The zone  $Z_2$  is defined taking into account the following:

- the structure is classified as a “civil building”;
- both internal systems (power and telecom) exist in this zone;
- no spatial shields exist;
- the structure is a single fireproof compartment;
- losses are assumed to correspond to the typical mean values of Table C.1.

The resulting factors valid for zone  $Z_2$  are reported in Table E.44.

**Table E.44 – Apartment block: Factors valid for zone Z<sub>2</sub> (inside the building)**

Input parameter		Comment	Symbol	Value	Reference
Type of floor		Wood	$r_t$	$10^{-5}$	Table C.3
Protection against shock (flash to structure)		none	$P_{TA}$	1	Table B.1
Protection against shock (flash to line)		none	$P_{TU}$	1	Table B.6
Risk of fire		Variable (see Table E.45)	$r_f$	–	Table C.5
Fire protection		Variable (see Table E.45)	$r_p$	–	Table C.4
Internal spatial shield		none	$K_{S2}$	1	Equation (B.6)
Power	Internal wiring	Unshielded (loop conductors in the same conduit)	$K_{S3}$	0,2	Table B.5
	Coordinated SPDs	None	$P_{SPD}$	1	Table B.3
Telecom	Internal wiring	Unshielded (large loops > 10m <sup>2</sup> )	$K_{S3}$	1	Table B.5
	Coordinated SPDs	None	$P_{SPD}$	1	Table B.3
L1: Loss of human life		Special hazard: None	$h_z$	1	Table C.6
		D1: due to touch and step voltage	$L_T$	$10^{-2}$	Table C.2
		D2: due to physical damage	$L_F$	$10^{-1}$	
Factor for persons in zone		$n_z / n_t \times t_z / 8\,760 = 200 / 200 \times 8\,760 / 8\,760$	–	1	

### E.5.3 Risk R<sub>1</sub> – Selection of protection measures

Risk R<sub>1</sub> values and the protection measures selected to reduce the risk to the tolerable level R<sub>T</sub> = 10<sup>-5</sup> are given in Table E.45, depending on the following parameters:

- height of the building *H*;
- reduction factor  $r_f$  for the risk of fire;
- reduction factor  $r_p$  reducing the consequences of fire;
- probability  $P_B$  depending on the class of LPS adopted.

**Table E.45 – Apartment block: Risk  $R_1$  for the apartment block depending on protection measures**

Height $H$ m	Risk of fire		LPS		Fire protection		Risk $R_1$ Values $\times 10^{-5}$	Structure protected $R_1 \leq R_T$
	Type	$r_f$	Class	$P_B$	Type	$r_p$		
20	Low	0,001	None	1	None	1	<b>0,837</b>	Yes
	Ordinary	0,01	None	1	None	1	<b>8,364</b>	No
			III	0,1	None	1	<b>0,776</b>	Yes
			IV	0,2	Manual	0,5	<b>0,747</b>	Yes
	High	0,1	None	1	None	1	<b>83,64</b>	No
			II	0,05	Automatic	0,2	<b>0,764</b>	Yes
			I	0,02	None	1	<b>1,553</b>	No
			I	0,02	Manual	0,5	<b>0,776</b>	Yes
	40	Low	0,001	None	1	None	1	<b>2,436</b>
None				1	Automatic	0,2	<b>0,489</b>	Yes
IV				0,2	None	1	<b>0,469</b>	Yes
Ordinary		0,01	None	1	None	1	<b>24,34</b>	No
			IV	0,2	Automatic	0,2	<b>0,938</b>	Yes
			I	0,02	None	1	<b>0,475</b>	Yes
High		0,1	None	1	None	1	<b>243,4</b>	No
			I	0,02	Automatic	0,2	<b>0,949</b>	Yes

## Bibliography

- [1] IEC 61000-4-5:1995, *Electromagnetic compatibility (EMC) – Part 4-5: Testing and measuring techniques – Surge immunity test*
  - [2] IEC 60079-10-1, *Explosive atmospheres – Part 10-1: Classification of areas – Explosive gas atmospheres*
  - [3] IEC 60079-10-2:2009, *Explosive atmospheres – Part 10-2: Classification of areas – Combustible dust atmospheres*
  - [4] IEC 60664-1:2007, *Insulation coordination for equipment within low-voltage systems – Part 1: Principles, requirements and tests*
  - [5] IEC 60050-426:2008, *International Electrotechnical Vocabulary – Part 426: Equipment for explosive atmospheres*
  - [6] Official Journal of European Union, 1994/28/02, n. C 62/63.
  - [7] ITU-T Recommendation K.47, *Protection of telecommunication lines using metallic conductors against direct lightning discharges*
  - [8] NUCCI C.A., *Lightning induced overvoltages on overhead power lines. Part I: Return stroke current models with specified channel-base current for the evaluation of return stroke electromagnetic fields*. CIGRE Electra No 161 (August 1995)
  - [9] NUCCI C.A., *Lightning induced overvoltages on overhead power lines. Part II: Coupling models for the evaluation of the induced voltages*. CIGRE Electra No 162 (October 1995)
  - [10] ITU-T Recommendation K.46, *Protection of telecommunication lines using metallic symmetric conductors against lightning-induced surges*
  - [11] IEC/TR 62066:2002, *Surge overvoltages and surge protection in low-voltage a.c. power systems - General basic information*
-